

# MOTORCYCLE CHAIN CATALOG 2024





## OEM adoption by motorcycle manufacturer

EK Chain & ThreeD Chain are adopted as genuine parts for the drive chains of Kawasaki and Bimota.



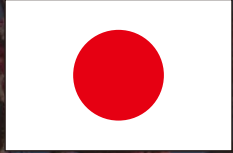

# Commitment to Japan Quality





# ThreeD LUXE

We are excited to introduce our new ThreeD LUXE, with the concept of providing the pleasure and satisfaction customized for all motorcycle users.

## ThreeD LUXE Features

### Chamfered Outer Plate



Precision forged outer plate  
L-series specific  
Weight reduction by 10%

### Drilled Pin



Lightweight design down to the finest details  
Weight reduction by 5-7%

### Inner Plate



Cost reduction by EK specification  
Lightweight design for center hole processing

### NX seal ring



The latest seal ring  
High performance and longer wear life

## 520L/525L/530L

L Series / STREET

Commitment to Japan Quality

**New Product!**

ThreeD LUXE L-series adopted "precision forged 3D shaped L-series specific outer plate", "reducing the chain weight by drilling pins" and "NX seal ring in high performance and longer wear life".

We have complete set of 520/525/530 size while inheriting ThreeD's luxury and high performance.

Best matched the motorcycle displacement range from 250cc to 1100cc.

CHAIN	PIN	PLATE THICKNESS		TENSILE	KG	WEAR LIFE	Seal Type	MAX cc	
	LENGTH MM	INNER MM	OUTER MM	KN	/100 L	INDEX STD. AS 100		STREET / OFF-ROAD	
520L/3D	19.45	2.0	2.0	37.8	1.52	3,500	NX	750	NA
525L/3D	21.80	2.2	2.2	40.0	1.76	3,600	NX	900	NA
530L/3D	23.45	2.2	2.2	40.0	1.88	3,700	NX	1,100	NA



\* Inner plate of ThreeD LUXE is not precision forged plate



## Products with optimized design of plate shape (Precision forged process) to improve transmission efficiency



Through precision forged process, 3D shape with reduced volume in the outer perimeter/minimizing stress enables a balance between strength and lightness. Furthermore, significant enhancement in transmission efficiency has been achieved by improving the precision of each parts and assembly accuracy.



### Chamfered Outer Plate



Lightweight design and aesthetic appeal  
10% weight reduction

### Chamfered Inner Plate



Technology focused on efficiency improvement  
4.1% weight reduction

### Drilled Pin



Weighting down to the smallest detail  
5 ~ 7% weight reduction



Exciting style encourages your customization further

To the custom user seeking the utmost

## ***520Z/525Z/530Z***

Z Series / SUPER SPORTS



Commitment to Japan Quality

Z-series was developed to deal with the high power torque generated by large-displacement machines.

It is specialized in high strength and high durability, making it a high-spec chain for street custom applications.

CHAIN	PIN	PLATE THICKNESS		TENSILE	KG	WEAR LIFE	Seal Type	MAX cc	
	LENGTH MM	INNER MM	OUTER MM	KN	/100 L	INDEX STD. AS 100		STREET / OFF-ROAD	
520Z/3D	20.80	2.2	2.2	41.6	1.69	3,500	QX2	1,000	NA
525Z/3D	23.10	2.4	2.4	44.5	1.90	3,600	QX2	1,200	NA
530Z/3D	25.60	2.6	2.6	49.8	2.24	3,700	QX2	1,400	NA

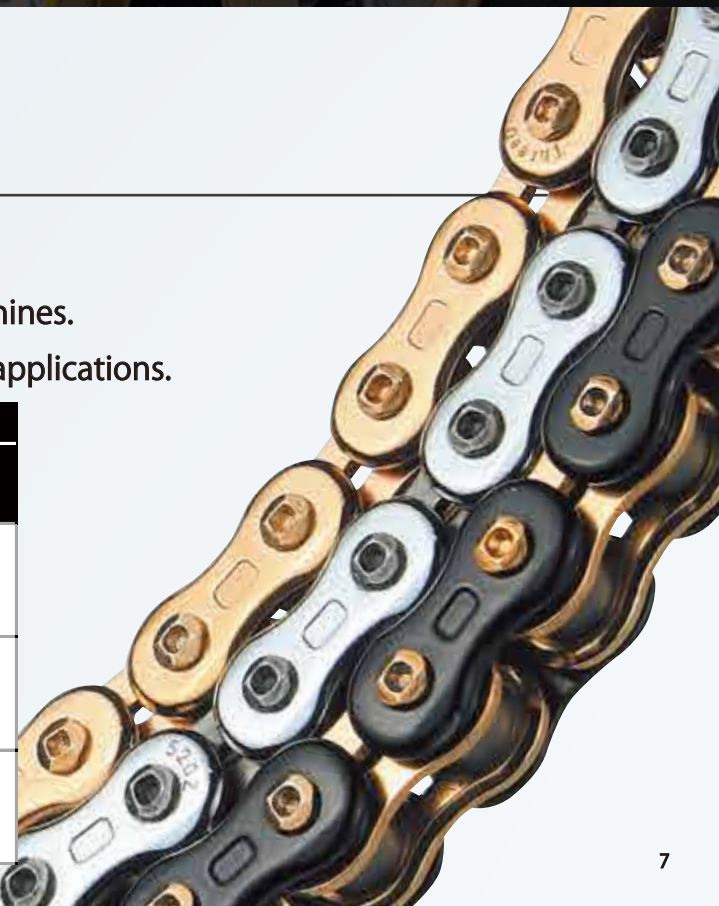



Freely touring anywhere and everywhere according to your own desires.

Robust specification supporting the ultimate performance

## 525SPR

SPR Series / HIGH POWER



Commitment to Japan Quality

Even though it is sized at 525, 525SPR possesses strength surpassing chains of 530 size. It is a super chain that maintains the OEM specifications capable of withstanding Kawasaki Ninja H2R 310PS performance, with offering two color options.



Kawasaki  
Ninja H2 CARBON / H2R



Kawasaki  
Z H2 SE

CHAIN	PIN	PLATE THICKNESS		TENSILE	KG	WEAR LIFE	Seal Type	MAX cc	
	LENGTH MM	INNER MM	OUTER MM	KN	/100 L	INDEX STD. AS 100		STREET / OFF-ROAD	
525SPR/3D	23.35	2.6	2.6	48.0	2.08	4,000	NX	1,300	NA



Motorcycle with minimal clearance between the chain and the frame may have a risk of interference.  
Please check the pin length and proceed with caution.





## Towards New World/Evolution of Control Performance

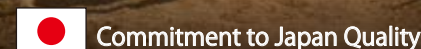

Incomparable Spec through Cutting-Edge Technology

# 520SP

RACING / ROADRACE for MotoGP

The pin and roller have been treated with OX-FPS processing to reduce friction.

520SP is a high-spec model chain designed to win races.

CHAIN	PIN	PLATE THICKNESS		TENSILE	KG	WEAR LIFE	Seal	MAX cc	
	LENGTH MM	INNER MM	OUTER MM	KN	/100 L	INDEX STD. AS 100		Type	STREET / OFF-ROAD
520SP/3D	18.60	2.0	2.0	39.6	1.50	2,800	SX2	1,000	NA

Pursuing Lightweight Design to Enhance Operability

# 520R

RACING / ROADRACE / SPORTS for Moto2

520R, which is a middle-class racing chain that satisfies all performance aspects from Moto2 racing support team (2023 PERTAMINA MANDALIKA SAG TEAM).



CHAIN	PIN	PLATE THICKNESS		TENSILE	KG	WEAR LIFE	Seal	MAX cc	
	LENGTH MM	INNER MM	OUTER MM	KN	/100 L	INDEX STD. AS 100		Type	STREET / OFF-ROAD
520R/3D	18.60	1.8	2.0	35.0	1.44	3,400	NX	750	NA



Durable and Stylish

# 520MXR

RACING / MOTOCROSS

520MXR which is the top-of-the-line model exclusively for motocross, has CRH pin treatment to enhance wear resistance. Additionally, the inner plates are treated with edge processing to prevent wear and deformation from dirt and sand.

CHAIN	PIN	PLATE THICKNESS		TENSILE	KG	WEAR LIFE	Seal	MAX cc	
	LENGTH MM	INNER MM	OUTER MM	KN	/100 L	INDEX STD. AS 100		Type	STREET / OFF-ROAD
520MXR/3D	17.50	2.0	2.0	38.5	1.41	450	-	NA	250 (2st) 500 (4st)

Demonstrate Toughness in Harsh Environments

# 520SM

RACING / ENDURO / MOTARD

By adopting the narrow seal ring, SX2-ring, the chain width has been reduced and lightweighting has also been achieved. 520SM is a sealed chain designed for off-road use, which also avoids interference with wide tires.



Narrow seal ring  
SX2-ring

CHAIN	PIN	PLATE THICKNESS		TENSILE	KG	WEAR LIFE	Seal	MAX cc	
	LENGTH MM	INNER MM	OUTER MM	KN	/100 L	INDEX STD. AS 100		Type	STREET / OFF-ROAD
520SM/3D	18.60	2.0	2.0	39.6	1.50	2,700	SX2	650	500



< Features of EK chain >

Lightening Hole

Technology to Enhance Excitement for Riding

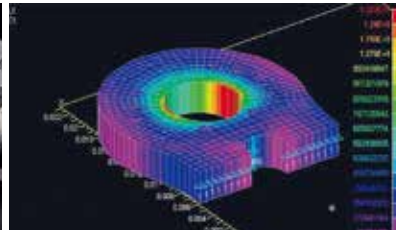
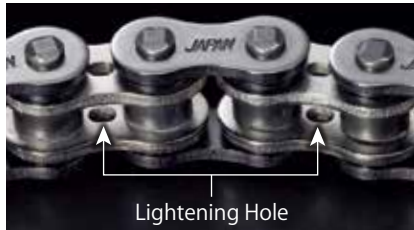

Achieved weight reduction through stress analysis  
 Excitement for Riding  
 Through stress analysis achieved weight reduction without compromising strength by creating holes in areas of low stress (indicated in purple) on the plate.

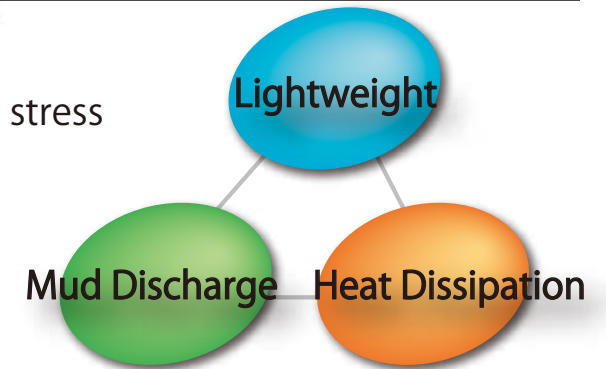

Chain Colors

A wide variety of color options to enhance vehicles

BLACK&BLACK

BLACK&GOLD

GOLD

METALLIC RED

METALLIC BLUE

GREEN

METALLIC ORANGE



\*The photo is for reference only and the actual color may appear different.

\* Please refer to page 25 for more color options.



Pleasure of controlling at will creates a sense of unity

Displacement up to 350cc motorcycle

Specifically designed to match with displacement

## LMX 520

STREET / ROADRACE / ENDURO



Commitment to Japan Quality



520LMX series has specifically designed to improve the machine performance up to 350cc.

As a result of designing for optimal strength, we have achieved a weight reduction of approx.

12% compared to 520SRX2, lightest among EK520's .

Using NX-Ring which adopted the high-specification model's, ensuring low friction and long-lasting.

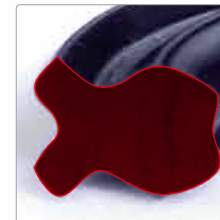

NX-Ring : Improved its durability by 15% compared to QX-Ring.

CHAIN	PIN	PLATE THICKNESS		TENSILE	KG	WEAR LIFE	Seal	MAX cc	
	LENGTH MM	INNER MM	OUTER MM	KN	/100 L	INDEX STD. AS 100	Type	STREET /	OFF-ROAD
520LMX	18.60	1.8	1.8	30.7	1.40	3,000	NX	350	350

## Quality that Promises Safety and Trust

Japan Quality O-Ring Chain At An Affordable Price

### **SRO** SERIES 420/428/520/525/530

STREET  Commitment to Japan Quality

The SRO series chains offer a value-priced O-ring chain that will not compromise on quality or durability. Features include lightening holes, high-tech heat-treated steel alloys and all the exact same quality and craftsmanship that EK puts into their entire product line.

CHAIN	PIN	PLATE THICKNESS		TENSILE	KG	WEAR LIFE	Seal Type	MAX cc	
	LENGTH MM	INNER MM	OUTER MM	KN	/100 L	INDEX STD. AS 100		STREET / OFF-ROAD	
420SRO	17.30	1.5	1.5	19.1	0.78	1,000	0	100	100
428SROZ	20.80	1.8	1.8	23.5	1.03	1,000	0	250	200
520SRO6	19.95	2.0	2.0	37.8	1.57	2,300	0	750	650
520SROZ2	20.80	2.2	2.2	40.0	1.76	2,400	0	750	650
525SROZ2	22.35	2.2	2.2	40.0	1.81	2,500	0	900	750
530SROZ2	24.00	2.2	2.2	40.0	1.92	2,500	0	1,000	750
630SRO	25.15	2.4	2.4	45.0	2.68	2,500	0	1,000	NA

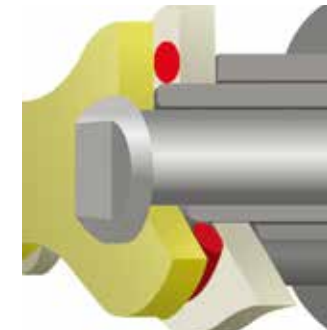

O-ring





Promising exceptional balance performance

## SRX SERIES 420/428/520/525/530

STREET



Commitment to Japan Quality

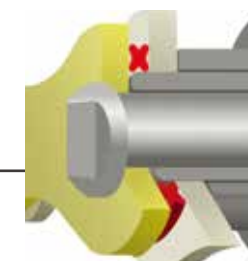

QX Ring

SRX series excels in the balance of performance and cost-effectiveness, earning the favor of many users.

While being a long-standing product, but it is incorporated improvements match with the times and the latest technology.

CHAIN	PIN	PLATE THICKNESS		TENSILE	KG	WEAR LIFE	Seal Type	MAX cc	
	LENGTH MM	INNER MM	OUTER MM	KN	/100 L	INDEX STD. AS 100		STREET /	OFF-ROAD
420SRX	16.80	1.5	1.5	20.5	0.77	2,400	QX	150	150
428SRX2	19.30	1.8	1.5	20.9	0.97	2,400	QX	250	200
520SRX2	19.95	2.0	2.0	37.8	1.54	3,300	QX	750	650
525SRX2	22.35	2.2	2.2	40.0	1.81	3,400	QX	1,000	750
530SRX2	24.00	2.2	2.2	40.0	1.92	3,500	QX	1,000	750



## Outstanding Performance that enhance the anticipation for driving

Our Supreme QX Ring Chains, The Ideal OE Replacement

### MVXZ SERIES 520/525/530

STREET / SPORTS

Commitment to Japan Quality

EK's MVXZ QX Ring chain is the ideal replacement chain for any 600 to 1100cc street bike. Features like lightening holes in the sideplates, large-diameter pins, and friction-reducing QX Rings help ensure high-performance and from 1 1/2 to 2 times increased wear life when compared to a standard O-Ring chain.

CHAIN	PIN	PLATE THICKNESS		TENSILE	KG	WEAR LIFE	Seal Type	MAX cc	
	LENGTH MM	INNER MM	OUTER MM	KN	/100 L	INDEX STD. AS 100		STREET /	OFF-ROAD
520MVXZ2	20.80	2.2	2.2	40.0	1.74	3,400	QX	1,000	750
525MVXZ2	22.75	2.2	2.4	41.8	1.89	3,500	QX	1,100	NA
530MVXZ2	24.40	2.2	2.4	41.8	2.01	3,600	QX	1,100	NA

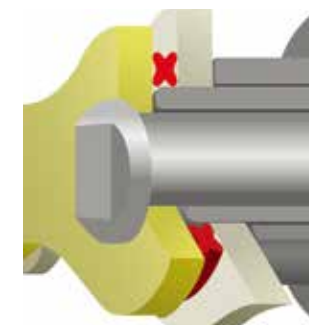

QX Ring





One step ahead in performance, achieved through evolution

## ZVX SERIES 428/520/525/530

SUPER SPORTS

Commitment to Japan Quality

ZVX series is EK's high-strength grade that meets the demands of high rigidity and durability for large-displacement machines in each chain size.

Experience performance that surpasses genuine parts by far.

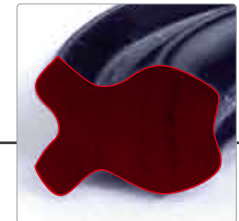

NX-Ring : Improved its durability by 15% compared to QX-Ring.

CHAIN	PIN	PLATE THICKNESS		TENSILE	KG	WEAR LIFE	Seal	MAX cc	
	LENGTH MM	INNER MM	OUTER MM	KN	/100 L	INDEX STD. AS 100	Type	STREET /	OFF-ROAD
428ZVX	20.80	2.0	2.0	29.5	1.15	2,700	QX	400 (single cylinder 600)	250
520ZVX3	20.80	2.2	2.4	41.8	1.80	3,900	NX	1,200	NA
525ZVX3	23.10	2.4	2.6	45.8	2.05	4,000	NX	1,300	NA
530ZVX3	24.70	2.4	2.6	48.9	2.18	4,000	NX	1,400	NA





## Inherited technology enhances street performance

Reinforced non-sealed chain with added durability to basic performance.

### **SR** SERIES 420/428/520/525/530

Reinforced non-sealed chain



Commitment to Japan Quality

The SR series features a unique protruding bushing design that is less prone to chain stiffening even during prolonged use.

Furthermore, it is a reinforced non-sealed chain that undergoes special heat treatment to enhance plate strength.

CHAIN	PIN	PLATE THICKNESS		TENSILE	KG	WEAR LIFE	Seal Type	MAX cc	
	LENGTH MM	INNER MM	OUTER MM	KN	/100 L	INDEX STD. AS 100		STREET / OFF-ROAD	
420SR	16.30	1.5	1.5	20.1	0.75	200	-	110	110
428SR	17.40	1.5	1.5	21.8	0.90	200	-	125	125
520SR	18.50	2.0	2.0	35.6	1.47	200	-	450	450
525SR	20.20	2.0	2.0	35.6	1.55	200	-	450	450
530SR	21.30	2.0	2.0	35.6	1.69	200	-	550	550

Protruding bushing to prevent stiffness

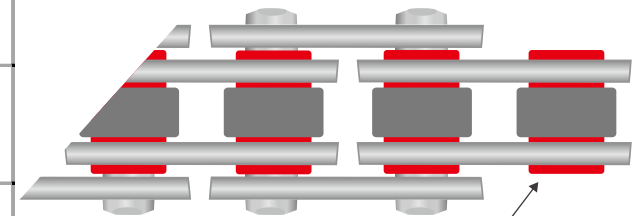

Reasonably priced while maintaining solid basic performance





## Japanese Quality, Manufactured Overseas

# ECO SERIES 420/428/520/525/530

STREET | Color Options: Steel only

This product meets the quality standards of EK JAPAN and is specialized for cost performance.

CHAIN	PIN	PLATE THICKNESS		TENSILE	KG	WEAR LIFE	Seal	MAX cc	
	LENGTH MM	INNER MM	OUTER MM	KN	/100 L	INDEX STD. AS 100	Type	STREET /	OFF-ROAD
420	14.60	1.5	1.5	19.1	0.72	100	-	80	80
428	16.60	1.6	1.6	19.5	0.87	100	-	100	80
420DEH	16.90	2.0	2.0	19.1	0.90	200	-	150	125
428DEH	17.80	1.8	1.8	21.8	0.96	200	-	150	125
520H	19.20	2.4	2.4	34.3	1.66	150	-	350	NA
525H	20.80	2.4	2.4	34.3	1.77	150	-	400	NA
530(50D)	20.60	2.0	2.0	32.9	1.65	100	-	400	NA
520DEX	20.00	2.0	2.0	36.0	1.57	3,100	QX	500	500
525DEX	23.20	2.4	2.4	38.0	1.86	3,200	QX	750	650
530DEX	24.85	2.4	2.4	38.0	1.96	3,300	QX	900	700

### High Quality • Durable

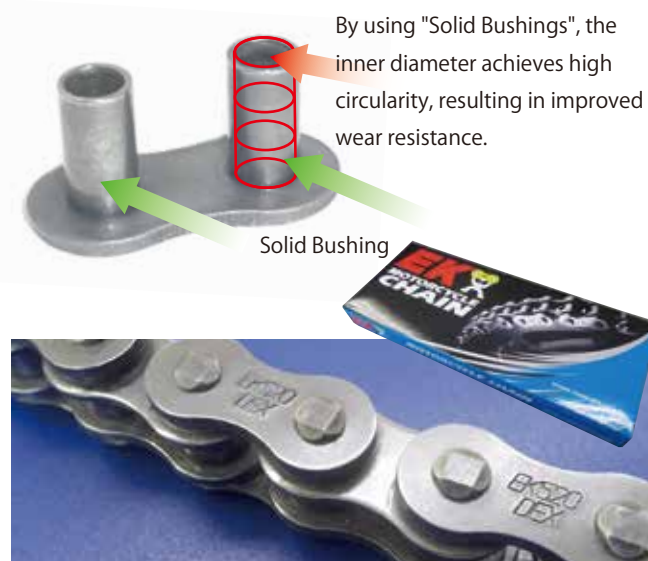

The DEX sealed chain utilizes Japanese-made QX ring seals and high-performance grease.



The joy of speeding through faster than anyone else

Providing an exhilarating and sporty driving experience



Commitment to Japan Quality

## R SERIES 415/520

### ROAD RACE

EK road racing chains are used to enhance durability in a wide range of road racing categories.

CHAIN	PIN	PLATE THICKNESS		TENSILE	KG	WEAR LIFE	Seal	MAX cc	
	LENGTH MM	INNER MM	OUTER MM	KN	/100 L	INDEX STD. AS 100	Type	STREET / OFF-ROAD	
415RR	13.70	1.5	1.5	20.5	0.69	450	-	125	85
415RRX	15.20	1.5	1.5	20.8	0.72	2,400	QX	250 (4st)	NA
520RRX	19.55	2.0	2.0	37.8	1.56	3,700	NX	1,000	NA
520RX	17.20	1.8	1.8	37.3	1.41	450	-	600	NA



## DRZ SERIES 530/630

### DRAG RACE

To withstand the unusual high loads in drag racing, we have developed custom plate thickness and size, making it the strongest in strength for the 530 series. It is a drag race-specific chain with a high reputation and proven track record overseas.

CHAIN	PIN	PLATE THICKNESS		TENSILE	KG	WEAR LIFE	Seal	MAX HP	
	LENGTH MM	INNER MM	OUTER MM	KN	/100 L	INDEX STD. AS 100	Type	DRAG RACE	
530DR2	23.00	2.4	2.4	46.7	2.16	450	-	250HP	
530DRZ2	24.80	3.2	2.6	51.1	2.43	450	-	300HP	
630MS	25.15	3.2	3.2	52.8	3.08	200	-	500HP	
630SHB	27.70	4.0	3.2	70.2	4.33	300	-	500HP	
630SHBZ	41.60	4.0	3.2	133	7.36	350	-	750HP	



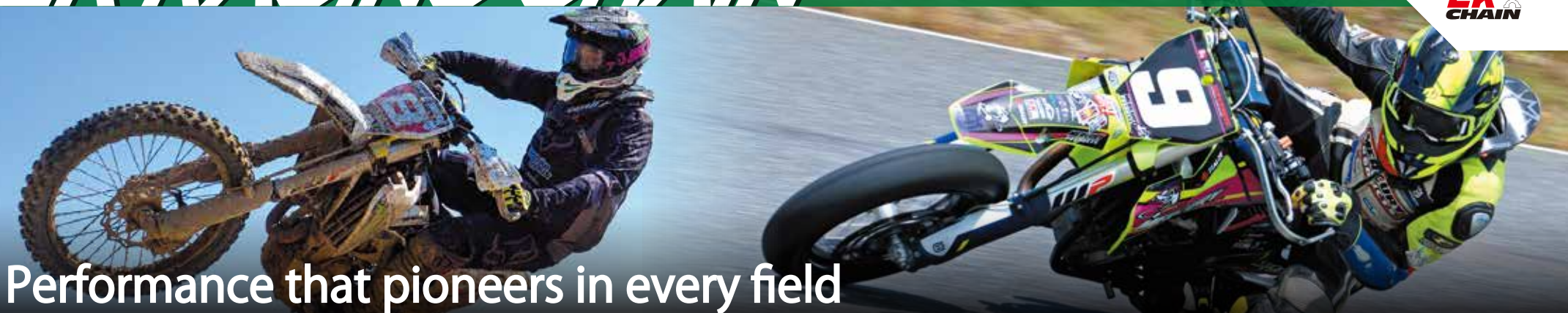

Performance that pioneers in every field

## SH/MRD SERIES 415/420/428/520

MOTOCROSS

Commitment to Japan Quality

Motocross-specific chains are designed to combine the light friction required for motocross with necessary durability for harsh environments, offering both impact resistance and wear resistance.

CHAIN	PIN		PLATE THICKNESS		TENSILE	KG	WEAR LIFE	Seal	MAX cc	
	LENGTH MM	INNER MM	OUTER MM	KN	/100 L	INDEX STD. AS 100	Type	STREET / OFF-ROAD		
415SH	13.00	1.5	1.5	18.6	0.56	200	-	80/NA		
420SH	17.30	2.0	2.0	23.1	0.91	200	-	NA	150	
428SHDR	19.00	1.8	1.8	22.2	0.99	450	-	NA	125	
520M3	17.50	2.0	2.0	36.5	1.36	450	-	NA	450	
520MRD7	17.50	2.0	2.0	39.7	1.47	450	-	NA	250 (2st) 500 (4st)	

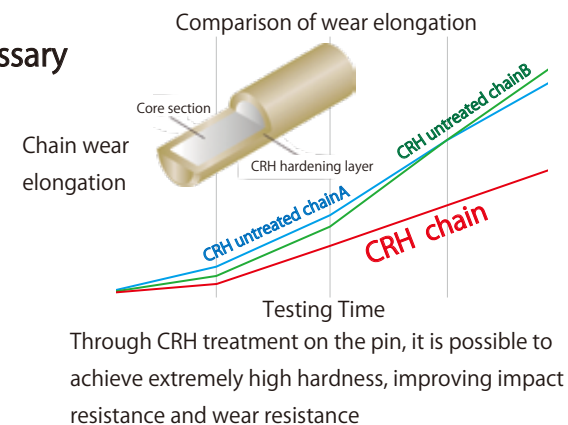

## RR/SM SERIES 520

Slim sealed chain

Commitment to Japan Quality

Narrow-spec specialized for clearance

By adopting the narrow seal ring, SX2-ring, the chain width has been reduced and lightweighting has also been achieved.

This prevents interference with wide tires and makes it ideal for vehicles with limited chain clearance, such as vintage motorcycles.

CHAIN	PIN		PLATE THICKNESS		TENSILE	KG	WEAR LIFE	Seal	MAX cc	
	LENGTH MM	INNER MM	OUTER MM	KN	/100 L	INDEX STD. AS 100	Type	STREET / OFF-ROAD		
520RR/SM	18.80	2.0	2.0	38.4	1.54	2,600	SX	600 (ST450)	500	

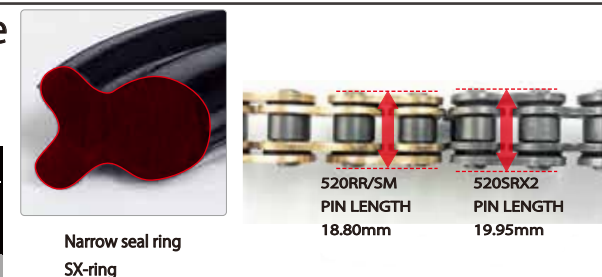

# Types of Connecting Links and Handling Instruction

## MLJ(Rivet Type)



MLJ is the standard connecting link for sealed chains.

Requires special riveting tool to install by press-fit the plates and mash the pin head

For more detailed information, you can find an introduction on YouTube through the QR code below.



## Flare Dimensions of MLJ

Pin diameter (mm)	Product	Riveting width (mm)
φ4.50	428SROZ,428SRX2,428ZVX	φ4.7~4.8
φ5.24	520RR/SM	φ5.45~5.5
φ5.38	520LMX,520SRO6,SROZ2,SRX2,MVXZ2,ZVX3, ThreeD LUXE L,ThreeD 520Z,525Z,520R,520SP	φ5.6~5.8
φ5.64	ThreeD 530Z,525SPR	φ5.8~5.9
φ5.95	630SRO	φ6.35

\*The figures are for reference purposes.

\* Replacing a chain and/or installing a connecting link are recommended to be performed by motorcycle shops, certified mechanics, or individuals with equivalent knowledge and experience in maintenance.

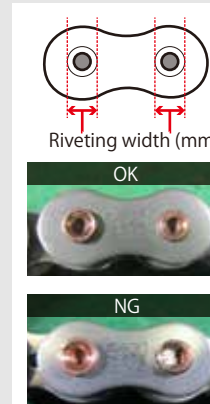

## SKJ (Semi-Press Fit Clip Type)



Link plate is the semi-press type and require tools such as a pair of pliers.

## How to install SKJ/SPJ



① Set the connecting link pin into the chain.



② Attach the outer plate.

SKJ : semi-press fit type, won't be able to fit by hand  
SPJ : loose type, can be installed without press-fitting



③ Use a pair of pliers to press-fit the SKJ outer plate.

\* Press the outer plate gradually.

## SPJ (Clip Type)



SPJ is the standard connecting link for non-sealed chains. Link plate is the loose-fit type (clearance fit) and no special tools are required for pressing the plate.

\* The sealed chains do not have SPJ settings. (For loose-type link plates, grease may leak between the pin and bushing.)



④ Attach the outer plate up to the groove where the clip fits, and then insert the clip.

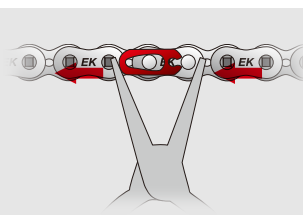

\* Attach the clip in the direction of the arrow.



⑤ Installation complete. Please verify the clip is securely seated in the groove.

EK' s screw type master links do not require any special tools for installation.

This unique patented link gives a rivet-like fit, using only an 8mm wrench and a pair of pliers.

### SLJ(Screw Type Connecting Link)

The sizes 520, 525, 530 are designated as options for the SRX2/MVXZ2/ZVX3 series for use as optional connectors.

#### Contents



Outer Plate with pins  
: One piece



Outer Plate  
: One piece



10 mm Nut  
: Two pieces



Seal ring  
: Four pieces



Plastic Tie : One piece

Grease  
: One pack

- ① Spread the grease on surface of the outer plate with pins, the outer plate and four pieces of seal ring.

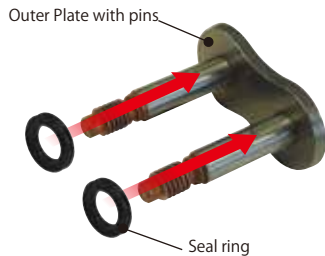

- ② Put two pieces of seal ring on the pins up to the bottom.

- ③ Insert the outer plate with pins into the bushings at the connection. Check if the insertion is complete.

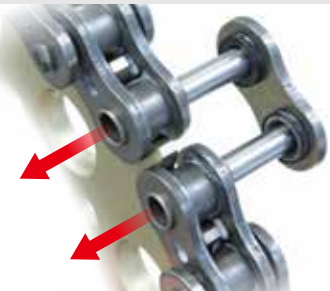

Caution: Cut new chain to the proper length before connect.

- ④ Put two pieces of seal rings on the projecting pins.

- ⑤ Fit the outer plate onto it.

Caution: Stamp should be on the outside (exterior) of the chain.

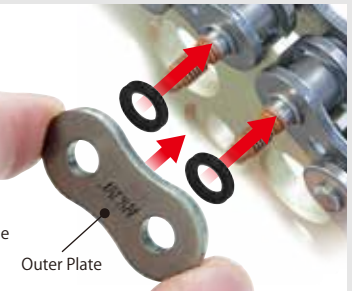

- ⑧ Remove the nuts and check that the outer plate is completely pushed as shown Fig. 1. If the outer plate is NOT completely pushed as shown Fig. 2, repeat steps ⑥ and ⑦

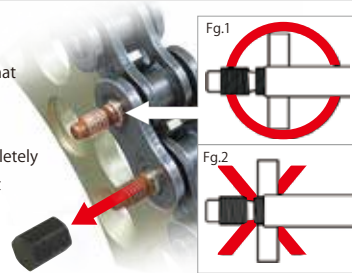

- ⑦ Tighten the right and left nuts with a wrench (10mm) by rotating 60° alternately to press the outer plate into the pins. Tighten the nuts completely until they won't move anymore. (Work with fingers as well)

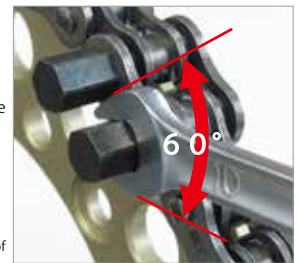

Caution: Excess load may break the groove of nuts and the nuts may not be able to be removed.

- ⑥ Screw the nuts on the pins until they cannot be rotated by fingers.



- ⑨ Screw the nut again at the point of Fig. 3. Hold the nut with the wrench and snap off the pins.



#### (CAUTION)

- ※Grease is removed on the chain in this instruction to show the process clearly.
- ※The outer plate should be pressed completely. Incomplete press fitting may cause a serious accident.
- ※When the pins are not snapped off, the pins may contact with body of motorcycle. Even if the pins are snapped off, the pins might contact with body of motorcycle. Check the chain's contact with body of the motorcycle carefully.
- ※The outer plate and the outer plate with the pins are designed larger than the main parts of the chain to increase strength.
- ※These nuts are no-perforation in order to avoid excessive press fitting of the outer plate. But excessive load may cause breakage on nut's groove and the nut may not be able to be removed.

# For a safe and fun motorcycle ride

## ⚠ Regular maintenance can prevent issues !

< Abnormal conditions requiring replacement >

### <Guideline for replacement>

< sealed chains >  
approx. 15,000 km to 30,000 km

< non-sealed chains >  
approx. ~5,000 km

\* Chain life varies based on factors such as usage environment, motorcycle type, maintenance frequency and maintenance method.

#### 1 Rusting



#### 2 Elongation

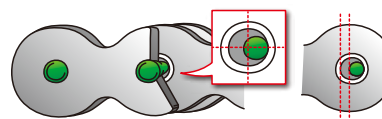

#### 3 Stiffness



#### 4 Cracks or detachment of seal rings

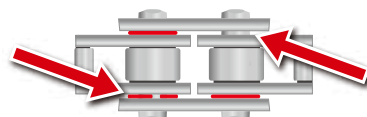

#### 5 Cracks or scratches on rollers, no rotation

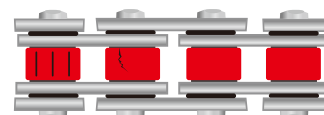

#### 6 Pin rotation



### For safety usage < EK CHAIN LIMITED WARRANTY >

EK sealed chains are warranted against manufacturer's defects in material and workmanship up to 1 year or 10,000 miles, whichever occurs first.

The warranty begins from the purchase date shown on the invoice/receipt.

This warranty is not applicable in any of the following cases.

1. Any applications other than those recommended by EK Chain and motorcycle owner's manual
2. Use in competitive events or in racing competitions
3. Use on motorcycles that have been modified in any way
4. Improper installment
5. Maintenance neglect including but not limited to lack of or improper lubrication, sprocket misalignment and improper chain adjustment
6. Normal wear

# Time to replace ! "Guidelines for the chain condition"

## Stains



clean, minimal dirt



dirt on the inner plate



dirt on the surface



severe dirt

## Insufficient Lubrication



well-lubricated and in good condition



excess lubrication



dry surface, lack of lubrication



insufficient lubrication, roller wear

safe

## Rust



no rust, good condition



rust on pin/plate surface



seal ring's deterioration, pin/bushing wear, steel powder oxidizing



danger

## Stiffness Deterioration



good condition



stiff, begin to appear irregularities

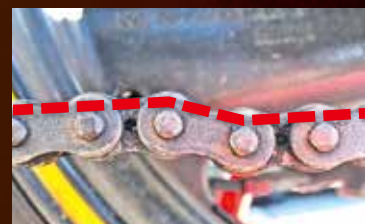

chain not flexure, line misalignment



seal ring failure, chain stiffness

# APPLICATION RANGE

Brand	PRODUCT NAME	Seal Type	50cc	80cc	100cc	110cc	125cc	150cc	200cc	250cc	350cc	400cc	450cc	500cc	550cc	600cc	650cc	700cc	750cc	900cc	1000cc	1100cc	1200cc	1300cc	1400cc		
	<b><u>ThreeD LUXE L Series</u></b>																										
	520L	NX-Ring																									
	525L																										
	530L																										
	<b><u>ThreeD Z Series</u></b>																										
	520Z	QX2-Ring																									
	525Z																										
	530Z																										
	<b><u>ThreeD SPR Series</u></b>																										
	520SPR	NX-Ring																									
	<b><u>ThreeD Racing Series</u></b>																										
	520SP	SX2-Ring																									
	520R	NX-Ring																									
	520MXR	Non-Sealed																									
	520SM	SX2-Ring																									
<b><u>LMX Series</u></b>																											
520LMX	NX-Ring																										
<b><u>SRO Series</u></b>																											
420SRO	O-Ring																										
428SROZ																											
520SRO6																											
520SROZ2																											
525SROZ2																											
530SROZ2																											
630SRO																											
<b><u>SRX Series</u></b>																											
420SRX	QX-Ring																										
428SRX2																											
520SRX2																											
525SRX2																											
530SRX2																											
<b><u>MXZ Series</u></b>																											
520MXZ2	QX-Ring																										
525MXZ2																											
530MXZ2																											
<b><u>ZVX Series</u></b>																											
428ZVX	QX-Ring																										
520ZVX3	NX-Ring																										
525ZVX3																											
530ZVX3																											
<b><u>SR Series Heavy Duty</u></b>																											
420SR	Non-Sealed																										
428SR																											
520SR																											
525SR																											
530SR																											
<b><u>Road Racing R Series</u></b>																											
415RR	Non-Sealed																										
415RRX	QX-Ring																										
520RRX	NX-Ring																										
520RX	Non-Sealed																										
<b><u>Motocross Racing SH/MD Series</u></b>																											
415SH	Non-Sealed																										
420SH																											
428SHDR																											
520M3																											
520MRD7																											
<b><u>Narrow-spec RR/SM Series</u></b>																											
520RR/SM	SX-Ring																										



# COLOR LINE-UP LIST

Brand	PRODUCT NAME	Steel	Chrome	Gold & Gold	Black & Gold	Black & Black	Red & Silver	Blue & Silver	Green & Silver	Orange & Silver	Black & Silver	Metallic Red & Silver	Metallic Blue & Silver	Metallic Green & Silver	Metallic Orange & Silver		
	<b><u>ThreeD LUXE L Series NX-ring</u></b>																
	520L		●	●	●												
	525L		●	●	●												
	530L		●	●	●												
	<b><u>ThreeD Z Series QX2-ring</u></b>																
	520Z		●	●	●												
	525Z		●	●	●												
	530Z		●	●	●												
	<b><u>ThreeD SPR Series NX-ring</u></b>																
	520SPR				●	●											
<b><u>ThreeD Racing Series</u></b>																	
520SP		●	●	●													
520R		●	●	●													
520MXR		●	●	●													
520SM		●	●	●													
<b><u>LMX Series NX-ring</u></b>																	
520LMX				●													
<b><u>SRO Series O-ring</u></b>																	
420SRO	●			●													
428SROZ	●			●			●	●	●	●	●						
520SRO6	●			●			●	●	●	●	●						
520SROZ2	●			●			●	●	●	●	●						
525SROZ2	●			●			●	●	●	●	●						
530SROZ2	●			●			●	●	●	●	●						
630SRO	●																
<b><u>SRX Series QX-ring</u></b>																	
420SRX	●			●													
428SRX2	●			●													
520SRX2	●	●		●	●	●	●	●	●	●	●	●	●	●	●	●	
525SRX2	●	●		●	●	●	●	●	●	●	●	●	●	●	●	●	
530SRX2	●	●		●	●	●	●	●	●	●	●	●	●	●	●	●	
<b><u>MVXZ Series QX-ring</u></b>																	
520MVXZ2	●	●		●	●	●	●	●	●	●	●						
525MVXZ2	●	●		●	●	●	●	●	●	●	●						
530MVXZ2	●	●		●	●	●	●	●	●	●	●						
<b><u>ZVX Series NX-ring (428ZVX exclusively features QX ring seals.)</u></b>																	
428ZVX	●			●													
520ZVX3	●	●		●	●	●	●	●	●	●	●						
525ZVX3	●	●		●	●	●	●	●	●	●	●						
530ZVX3	●	●		●	●	●	●	●	●	●	●	●	●	●	●	●	
<b><u>SR Series Heavy Duty non-sealed</u></b>																	
420SR	●	●		●	●												
428SR	●						●	●	●	●	●						
520SR	●																
525SR	●																
530SR	●																
<b><u>Road Racing R Series</u></b>																	
415RR				●													
415RRX				●													
520RRX				●													
520RX				●													
<b><u>Motocross Racing SH/MRD Series</u></b>																	
415SH	●																
420SH	●			●													
428SHDR	●			●													
520M3	●			●													
520MRD7	●			●			●	●	●	●	●						
<b><u>Narrow-spec RR/SM Series</u></b>																	
520RR/SM				●													

We sell colors with black circles on the chart.



The second corner  
EK Chain Corner



In Japan, at the Autopolis circuit, EK banners are displayed,  
cheering on the riders as they race.



株式会社 江沼チェーン製作所

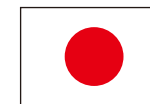

ENUMA CHAIN MFG. CO., LTD.

300, Kamikawasaki-machi, Kaga-shi, Ishikawa, 922-8678 Japan

[www.enuma.co.jp](http://www.enuma.co.jp)



当社は日本チェーン工業会の  
オフィシャルメンバーです。

