

2017





WE KNOW HOW

Since its introduction in 1999, WRP has offered a technical range of top-level products for motorcycles. In fact the more than 30 years of riding experience of the R&D staff of Wind Trading Group has been immensely decisive in developing a prosperous future for WRP. The WRP brand relies on two factors: a strong sponsorship program that endorses the name in the racing industry and intense testing on the tracks that optimizes the performance of those products used by top riders and top teams competing in the highest expression of motorcycle racing in the world. They are in FIM World Championships of MotoGP, Superbike, Supersport, Motocross, Enduro, Freestyle MX, Supermoto and Rally, as well in American AMA Supercross and Motocross.

From 1999 and on, WRP has been endorsed by MotoGP Team Kenny Roberts, Moto2 Teams Interwetten, Speed Up, J1R, Italtrans, Kiefer and SAG and Superbike Teams BMW Italia and Aprilia Pata, Motocross Teams Yamaha Rinaldi, Pro Circuit Kawasaki, CLS Kawasaki, Kemea Yamaha, Husqvarna Ricci Factory, Silver Action KTM and Sarholz KTM, Enduro Team Husqvarna Azzalin Factory, Supermoto Factory Teams Honda, Husqvarna, KTM and Suzuki, and over 100 Grand Prix stars that have won over 30 FIM World and U.S. AMA Championships.

MOTO GP, Moto2, 500, 250, 125

Kenny Roberts Jr, Jeremy McWilliams, Nobuatsu Aoki, Kurtis Roberts, Alex De Angelis, Stefan Bradl, Thomas Lüthi, Julian Simon, Mike di Meglio, Xavier Simeon, Johann Zarco, Roberto Rolfo, Raffaele De Rosa, Anthony West, Shane Byrne, Sandro Cortese, Marcel Schroetter, Louis Rossi

SUPERBIKE & SUPERSPORT

Troy Corser, John Kocinski, Troy Bayliss, Jörg Teuchert, Marco Melandri, Noriyuki Haga, Chaz Davies, Ruben Xaus, Regis Laconi, James Toseland, Lorenzo Lanzi, Michel Fabrizio, Max Neukirchner, Haruchika Aoki, Doriano Romboni, Ayrton Badovini, Jakub Smrz

FIM MOTOCROSS

Joel Smets, Andrea Bartolini, Romain Febvre, Christophe Pourcel, Sebastien Pourcel, David Philippaerts, Steven Frossard, Christophe Charlier, Ben Townley, Tyla Rattray, Alessio Chiodi, Jonathan Barragan, Yves DeMaria, Marc De Reuver, Ken De Dycker, Shayne King, Max Nagl, Nicolas Aubin, Andrew McFarlane, Luigi Seguy, Anthony Boissiere, Johnny Aubert, Christian Burnham, Patrick Caps, Jeff Dement, Manuel Monni, Marko Kovalainen, Matti Seistola, Kenneth Gundersen, Davide Guarneri, Alex Salvini, Marcus Schiffer, Antti Pyrhonen, Jonny Lindhe, Joaquim Rodrigues, Michael Leib, Alessandro Lupino, José Butron, Wyatt Avis, Marco Maddii, Khounsith Vongsana, Gert Krestinov, Tim Gajser, Henry Jacobi, Dennis Ulrich, Joel Roelants, Tommy Searle, Filip Bengtsson, Jeremy Van Horebeek, Benoit Paturel, Brent Vandonink, Damon Graulus, Kei Yamamoto, Kiara Fontanesi

U.S.A. AMA SUPERCROSS & MOTOCROSS

Ryan Villopoto, Grant Langston, Ivan Tedesco, Mike Brown, Matt Walker, Ben Townley, Mike Craig, Tyla Rattray, Brett Metcalfe, Stephane Roncada, Austin Stroupe, Christophe Pourcel, Jake Weimer, Josh Hansen, Blake Baggett, Dean Wilson, Broc Tickle, Darryn Durham, Martin Davalos, Justin Hill, Chris Alldredge, Tyler Bowers, Adam Cianciarulo, Joey Savatgy, Arnaud Tonus

ENDURO / SIX DAYS

Antoine Meo, Simone Albergoni, Juha Salminen, Matti Seistola, Sebastien Guillame, Alex Salvini

FREESTYLE MOTOCROSS

Øystein Kyørstad, Massimo Bianconcini

SUPERMOTO

Eddy Seel, Gerald Delepine, Adrien Chareyre, Thomas Chareyre, Davide Gozzini, Ivan Lazzarini, Jerome Giraud, Mauno Hermunen, Massimo Manzo, Fabio Balducci, William Rubio, Fabrice Guyot, Simone Girolami, Jorge Nestor, Massimo Beltrami, Trampas Parker, Max Verderosa, Christian Ravaglia, Lorenzo Mariani

RALLY

Fabrizio Meoni, Isidre Esteve, Chaleco Lopez, Alex Zanotti, Paolo Ceci



pages 12-17
OFF-ROAD CONTROLS



pages 46-49
OFF-ROAD SPROCKETS



pages 18-21
STREET CONTROLS



pages 50-55
OFF-ROAD PROTECTIONS



pages 22-28
OFF-ROAD CONTROLS



pages 56-57
OFF-ROAD AIR & OIL FILTERS



pages 29-31
OFF-ROAD BEARINGS & COMPONENTS



pages 58-73
OFF-ROAD PLASTICS



pages 32-37
OFF-ROAD BRAKE DISCS & PADS



page 74
LEISURE WEAR



pages 38-41
STREET BRAKE PADS



page 75
CANOPIES / TENTS



pages 42-43
OFF-ROAD CHAINS



page 76-77
MOTO-TECHNICA CLUTCH DISCS



pages 44-45
STREET CHAINS



page 78-79
J-GASKETS LINE

WRP STREET

CONTROLS
BRAKE PADS
CHAINS
CANOPIES / TENTS

WRP OFF-ROAD

CONTROLS
BEARINGS & COMPONENTS
BRAKE DISCS
BRAKE PADS
CHAINS
SPROCKETS
PROTECTIONS
AIR & OIL FILTERS
PLASTICS
CANOPIES / TENTS

WRP RIDERS



Kiara Fontanesi



Joey Savatgy



Austin Forkner



2015 & 2016 MXoN Champion



Jeremy Van Horebeek



Julian Simón



Sam Lowes



Cal Crutchlow



Jonas Folger



Sandro Cortese



Simone Corsi



Jack Miller



Steven Frossard



David Philippaerts



Tommy Searle



Adrien Chareyre



Supersport start: photo courtesy of Enzo Tempestini



Blake Baggett



Tom Luthi



Xavier Simeon



Chaz Davies

Marco Melandri



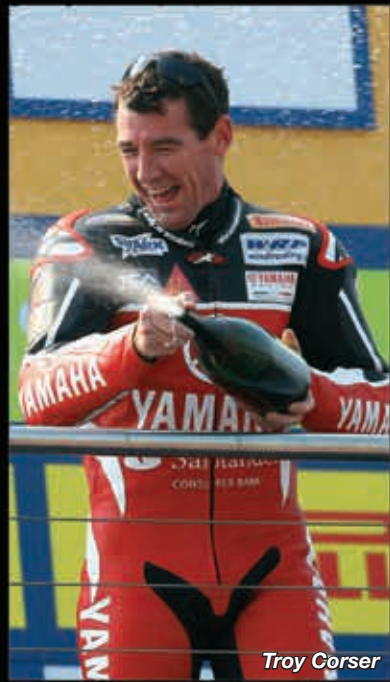

Troy Corser

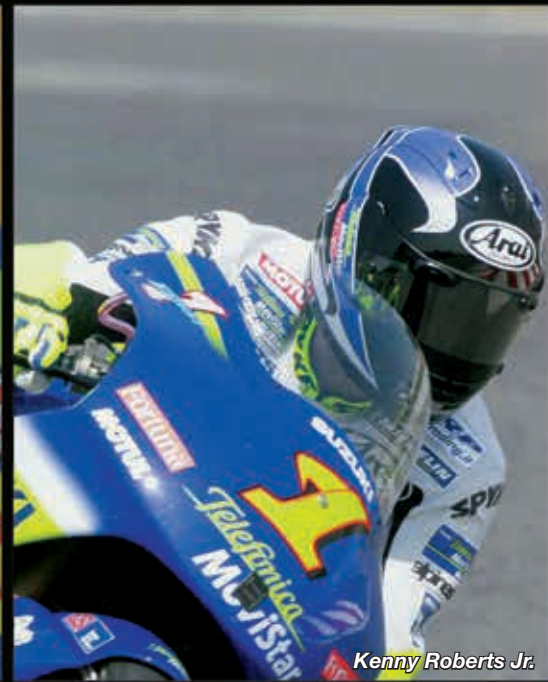

Kenny Roberts Jr.



Fabrizio Meoni
we will never forget you



Stefan Bradl



Troy Bayliss



Noriyuki Haga



Ruben Xaus

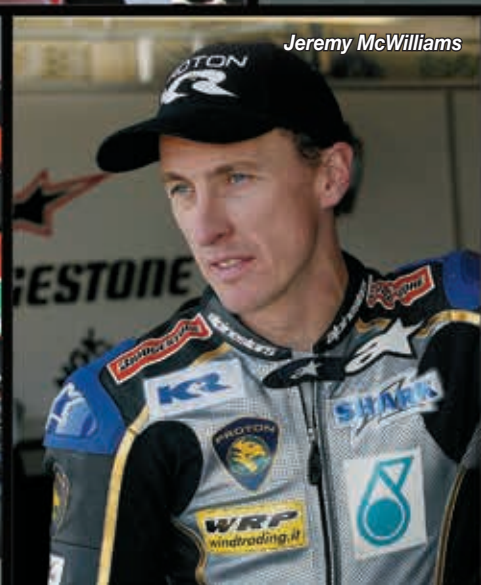

Jeremy McWilliams



Regis Laconi



Ben Townley



Andrew McFarlane



Joël Smets



Max Nagl



Chicco Chiodi



Ivan Lazzarini



Gerald Delepine



Yves DeMaria



Thomas Chareyre



Christophe Pourcel



Eddy Seel



Team Italy
2003 MXdN



Antoine Meo

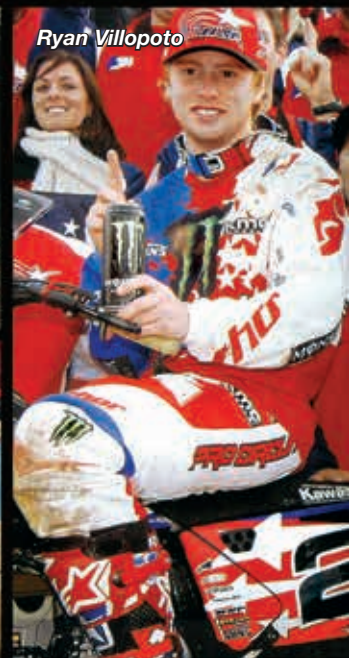

Ryan Villopoto



Andrea Bartolini

**ROMAIN
FEBVRE #461**





WRP STREET

- CONTROLS
- BRAKE PADS
- CHAINS
- CANOPIES / TENTS

WRP OFF-ROAD

- CONTROLS
- BEARINGS & COMPONENTS
- BRAKE DISCS
- BRAKE PADS
- CHAINS
- SPROCKETS
- PROTECTIONS
- AIR & OIL FILTERS
- PLASTICS
- CANOPIES / TENTS



PADS

- SHINY CLEAR VINYL WITH SUB-SURFACE PRINT

PRO-PAD / MX HANDLEBAR CROSSBAR PADS		
APPLICATION	COLOUR	P/N
UNIVERSAL	WRP / BLACK-RED	WD-4001
UNIVERSAL	WRP / BLACK-BLUE	WD-4002
UNIVERSAL	WRP / WHITE-RED	WD-4005
UNIVERSAL	WRP / ITALIAN FLAG	WD-4003
UNIVERSAL	WRP / FRENCH FLAG	WD-4004
UNIVERSAL	WRP / BELGIAN FLAG	WD-4006
UNIVERSAL	WRP / GERMAN FLAG	WD-4007
UNIVERSAL	WRP / BRAZILIAN FLAG	WD-4009
UNIVERSAL	WRP / U.S.A. FLAG	WD-4010
MINI-X	WRP / BLACK-RED	WD-4008



"TAPER-X" OVERSIZE HANDLEBAR

- TESTED AND DEVELOPED BY TOP GP RIDERS LIKE WORLD CHAMPIONS JOËL SMETS, ANDREA BARTOLINI, CHICCO CHIODI AND EDDY SEEL
- MADE FROM ULTRA STRONG AND LIGHTWEIGHT 7075-T6 ALUMINUM
- PATENTED TAPER-WALL CONSTRUCTION WITH CROSSBRACE SYSTEM FOR ADDITIONAL STRENGTHENING AND SUFFICIENT FLEX
- 28,6 MM. CLAMPING AREA DIAMETER
- ANODIZED SHOT-PEENED FINISH
- LASER-ETCHED POSITION GRID
- KNURLING AT THE LEFT GRIP AREA TO PREVENT GRIP SLIPPAGE
- CROSSBAR PAD INCLUDED





TAPER-X / OVERSIZE Ø 28.6 mm TAPERED HANDLEBAR WITH CROSSBAR			
APPLICATION	BEND	COLOUR	P/N
MX / ENDURO	MINI 85	BLACK	WD-9201-014
MX / ENDURO	MINI 85 - HIGH	BLACK	WD-9206-014
MX / ENDURO	GP - LOW	BLACK	WD-9202-014
MX / ENDURO	GP - LOW	TITANIUM	WD-9202-022
MX / ENDURO	GP - MID	BLACK	WD-9205-014
MX / ENDURO	GP - MID	TITANIUM	WD-9205-022
MX / ENDURO	GP REPLICA	BLUE	WD-9203-002
MX / ENDURO	GP REPLICA	RED	WD-9203-003
MX / ENDURO	GP REPLICA	BLACK	WD-9203-014
MX / ENDURO	GP REPLICA	TITANIUM	WD-9203-022
MX / ENDURO	GP REPLICA	BLACK	WD-9207-014
MX / ENDURO	KIARA FONTANESI REPLICA	FUCHSIA	WD-9203-025
MX / ENDURO	CHIODI 06 REPLICA	BLUE	WD-9204-002
MX / ENDURO	CHIODI 06 REPLICA	BLACK	WD-9204-014
MX / ENDURO	CHIODI 06 REPLICA	TITANIUM	WD-9204-022
SUPERMOTO	SEEL REPLICA	BLACK	WD-9209-014



WRP STREET
 CONTROLS
 BRAKE PADS
 CHAINS
 CANOPIES / TENTS

"TAPER-X" OVERSIZE HANDLEBARS MEASURES / DIMENSIONS TABLE						
P/N	APPLICATION	A [mm]	B [mm]	C [mm]	D [mm]	α [°]
WD-9201-...	"TAPER-X" OVERSIZE - MX MINI 85	740	118	42	120	14,5
WD-9202-...	"TAPER-X" OVERSIZE - MX-GP LOW	808	77	42	145	15,5
WD-9203-...	"TAPER-X" OVERSIZE - MX-GP REPLICA	802	99	54	130	14
WD-9204-...	"TAPER-X" OVERSIZE - CHIODI REPLICA	803	95	40	140	12
WD-9205-...	"TAPER-X" OVERSIZE - MX-GP MID	805	93	54	140	14
WD-9206-...	"TAPER-X" OVERSIZE - MX MINI 85 - HIGH	800	138	100	120	16,5
WD-9207-...	"TAPER-X" OVERSIZE - MX-GP REPLICA	803	92	56	140	15
WD-9209-...	"TAPER-X" OVERSIZE - SEEL REPLICA	802	99	54	140	14

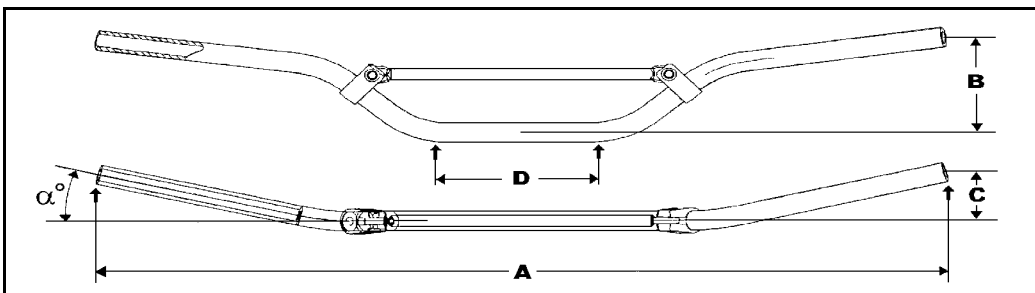

WRP OFF-ROAD
 CONTROLS
 BEARINGS & COMPONENTS
 BRAKE DISCS
 BRAKE PADS
 CHAINS
 SPROCKETS
 PROTECTIONS
 AIR & OIL FILTERS
 PLASTICS
 CANOPIES / TENTS





PRO-TECH / Ø 22 mm 7075-T6 ALUMINUM HANDLEBAR WITH PAD			
APPLICATION	BEND	COLOUR	P/N
HONDA	CR / CRF 04>	DARK GREY	WD-1001-025
HONDA	CR - HIGH	DARK GREY	WD-1030-025
HONDA MINI	MX 85	DARK GREY	WD-1080-025
KAWASAKI MINI	MX 85 - HIGH	DARK GREY	WD-1090-025
TRIAL	UNIVERSAL	DARK GREY	WD-3010-025
ATV / QUAD	UNIVERSAL	DARK GREY	WD-3100-025

"PRO-TECH" HANDLEBARS

- MADE FROM 7075-T6 ALUMINUM ALLOY
- FORGED CROSSBAR CLAMPS
- LASER-ETCHED POSITION GRID
- ANODIZED SHOT-PEENED FINISH
- CROSSBAR PAD INCLUDED



PRO-ALU / Ø 22 mm 6082-T6 ALUMINUM HANDLEBAR WITH PAD			
APPLICATION	BEND	COLOUR	P/N
HONDA	CR / CRF 04>	SILVER	WD-T2001-016
HONDA	CR - HIGH	SILVER	WD-T2030-016
YAMAHA	YZ / YZF	SILVER	WD-T2060-016
MINI	MX 65	SILVER	WD-T2070-016
HONDA MINI	MX 85	SILVER	WD-T2080-016
KAWASAKI MINI	MX 85 - HIGH	SILVER	WD-T2090-016

"PRO-ALU" HANDLEBARS

- MADE FROM 6082-T6 ALUMINUM ALLOY
- FORGED CROSSBAR CLAMPS
- ANODIZED SHOT-PEENED FINISH
- CROSSBAR PAD INCLUDED



TAPERED OVERSIZE HANDLEBARS MEASURES / DIMENSIONS TABLE						
P/N	APPLICATION	A [mm]	B [mm]	C [mm]	D [mm]	α [°]
WD-9001-...	TAPERED OVERSIZE - LOW	808	77	42	145	15
WD-9002-...	TAPERED OVERSIZE - MEDIUM	805	80	60	145	15,5
WD-9003-...	TAPERED OVERSIZE - HIGH	805	100	55	145	13
WD-9005-...	TAPERED OVERSIZE - GP REPLICA	803	95	54	150	14
WD-9006-...	TAPERED OVERSIZE - BMW GS 1200 04-07	770	170	100	130	23
WD-9007-...	TAPERED OVERSIZE - FEBVRE REPLICA	803	95	54	150	14
WD-9009-...	TAPERED OVERSIZE - SEEL REPLICA	802	99	54	140	14

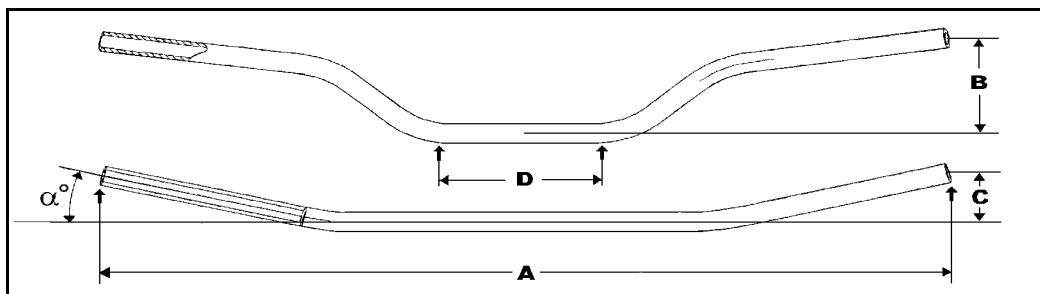

PRO-TECH / PRO-ALU HANDLEBARS MEASURES / DIMENSIONS TABLE						
P/N	APPLICATION	A [mm]	B [mm]	C [mm]	D [mm]	α [°]
WD-1001-... / WD-T2001-.	HONDA CR / CRF - 04> BEND	802	99	54	160	14
WD-1030-... / WD-T2030-.	HONDA CR - HIGH BEND	802	114	50	160	13
WD-T2060-...	YAMAHA YZ BEND	798	90	58	135	15
WD-2070-...	MINI MX 65	746	95	85	120	18
WD-1080-... / WD-T2080-.	MINI MX 85	746	115	42	120	13,5
WD-1090-... / WD-T2090-.	MINI MX 85 - HIGH BEND	800	132	63	105	16,5
WD-3010-...	TRIAL	810	120	60	140	13
WD-3100-...	ATV / QUAD	800	132	63	160	16,5



WRP STREET

- CONTROLS
- BRAKE PADS
- CHAINS
- CANOPIES / TENTS



THE 2015 MXGP WORLD CHAMPION HANDLEBAR

WRP OFF-ROAD

- CONTROLS
- BEARINGS & COMPONENTS
- BRAKE DISCS
- BRAKE PADS
- CHAINS
- SPROCKETS
- PROTECTIONS
- AIR & OIL FILTERS
- PLASTICS
- CANOPIES / TENTS

PRO-BAR / OVERSIZE Ø 28.6 mm TAPERED HANDLEBAR W/ PAD			
APPLICATION	BEND	COLOUR	P/N
MX / ENDURO	LOW	BLACK	WD-9001-014
MX / ENDURO	LOW	SILVER	WD-9001-016
MX / ENDURO	MEDIUM	BLACK	WD-9002-014
MX / ENDURO	MEDIUM	SILVER	WD-9002-016
MX / ENDURO	HIGH	BLACK	WD-9003-014
MX / ENDURO	HIGH	SILVER	WD-9003-016
MX / ENDURO	GP REPLICA	BLACK	WD-9005-014
MX / ENDURO	GP REPLICA	TITANIUM	WD-9005-022
MX / ENDURO	FEBVRE REPLICA	BLUE	WD-9007-002
MX / ENDURO	FEBVRE REPLICA	BLACK	WD-9007-014
SUPERMOTO	SEEL REPLICA	BLACK	WD-9009-014



“PRO-BAR” OVERSIZE HANDLEBARS

- MADE FROM ULTRA STRONG AND LIGHTWEIGHT 7075-T6 ALUMINUM
- PATENTED TAPER-WALL CONSTRUCTION - 28,6 MM. CLAMPING AREA DIAMETER
- ANODIZED SHOT-PEENED FINISH
- LASER-ETCHED POSITION GRID
- KNURLING AT THE LEFT GRIP AREA TO PREVENT GRIP SLIPPAGE
- PAD INCLUDED

PRO-KIT / OVERSIZE Ø 28.6 mm TAPERED HANDLEBAR (COMPLETE KIT)			
APPLICATION	BEND	COLOUR	P/N
MX / ENDURO	LOW	BLACK	WD-9101-014
MX / ENDURO	LOW	SILVER	WD-9101-016
MX / ENDURO	MEDIUM	BLACK	WD-9102-014
MX / ENDURO	MEDIUM	SILVER	WD-9102-016
MX / ENDURO	HIGH	BLACK	WD-9103-014
MX / ENDURO	HIGH	SILVER	WD-9103-016
MX / ENDURO	GP REPLICA	TITANIUM	WD-9105-022
SUPERMOTO	SEEL REPLICA	BLACK	WD-9109-014



PRO-BAR “DUAL SPORT” / OVERSIZE Ø 28.6 mm TAPERED HANDLEBAR			
APPLICATION	BEND	COLOUR	P/N
BMW GS 1200	04-07	SILVER	WD-9006-016



THE “PRO-KIT” INCLUDES OVERSIZE TAPERED HANDLEBAR AND WD-9000 ADAPTER MOUNTING KIT



AMERICA SERIES



"O-S AMERICA" OVERSIZE HANDLEBARS

- MADE FROM ULTRA STRONG AND LIGHTWEIGHT ALUMINUM ALLOY
- 28,6 MM. CLAMPING AREA DIAMETER
- ANODIZED SHOT-PEENED FINISH
- LASER-ETCHED POSITION GRID
- KNURLING AT THE LEFT GRIP AREA TO PREVENT GRIP SLIPPAGE
- PAD INCLUDED

O-S AMERICA / OVERSIZE Ø 28.6 mm TAPERED HANDLEBARS			
APPLICATION	BEND	COLOUR	P/N
MX / ENDURO	LOW	BRONZE	WD-AM001-022
MX / ENDURO	LOW	BLACK	WD-AM001-014
MX / ENDURO	MEDIUM	BRONZE	WD-AM002-022
MX / ENDURO	MEDIUM	BLACK	WD-AM002-014

"O-S AMERICA" OVERSIZE HANDLEBARS MEASURES / DIMENSIONS TABLE						
P/N	APPLICATION	A [mm]	B [mm]	C [mm]	D [mm]	α [°]
WD-AM001-...	OFF ROAD HANDLEBAR Ø 28.6 mm - LOW	810	60	58	140	14
WD-AM002-...	OFF ROAD HANDLEBAR Ø 28.6 mm - HIGH	803	95	40	130	12,5

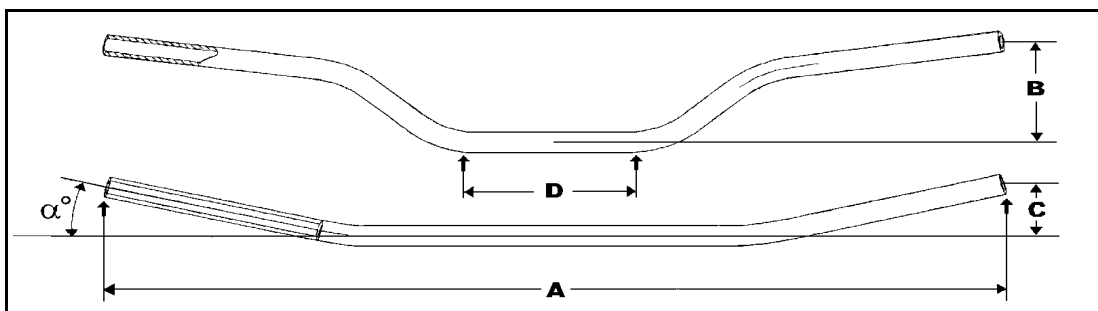

PAD-FAT / MX OVERSIZE HANDLEBAR PAD		
APPLICATION	COLOUR	P/N
UNIVERSAL	BLACK / WRP BLACK-RED	WD-4900

"PAD-FAT"

- SHINY CLEAR VINYL WITH SUB-SURFACE PRINT
- ULTRA LIGHTWEIGHT INJECTED POLYURETHANE PAD



AMERICA SERIES



WRP STREET
 CONTROLS
 BRAKE PADS
 CHAINS
 CANOPIES / TENTS

"X-BAR AMERICA" OVERSIZE HANDLEBAR

- MADE FROM ULTRA STRONG AND LIGHTWEIGHT ALUMINUM ALLOY
- TAPER-WALL CONSTRUCTION WITH CROSSBRACE SYSTEM FOR ADDITIONAL STRENGTHENING AND SUFFICIENT FLEX
- 28,6 MM. CLAMPING AREA DIAMETER
- ANODIZED SHOT-PEENED FINISH
- LASER-ETCHED POSITION GRID
- KNURLING AT THE LEFT GRIP AREA TO PREVENT GRIP SLIPPAGE
- CROSSBAR PAD INCLUDED



WRP OFF-ROAD
 CONTROLS
 BEARINGS & COMPONENTS
 BRAKE DISCS
 BRAKE PADS
 CHAINS
 SPROCKETS
 PROTECTIONS
 AIR & OIL FILTERS
 PLASTICS
 CANOPIES / TENTS

X-BAR AMERICA / OVERSIZE Ø 28.6 mm TAPERED HANDLEBARS W/ CROSSBAR			
APPLICATION	BEND	COLOUR	P/N
MX / ENDURO	HONDA / KAW	BRONZE	WD-AM203-022
MX / ENDURO	HONDA / KAW	BLACK	WD-AM203-014
MX / ENDURO	MEDIUM	BRONZE	WD-AM207-022
MX / ENDURO	MEDIUM	BLACK	WD-AM207-014

"X-BAR AMERICA" OVERSIZE HANDLEBARS MEASURES / DIMENSIONS TABLE

P/N	APPLICATION	A [mm]	B [mm]	C [mm]	D [mm]	α [°]
WD-AM203-...	"X-BAR AMERICA" OVERSIZE - HONDA/KAW BEND	802	99	54	130	14
WD-AM207-...	"X-BAR AMERICA" OVERSIZE - GP MEDIUM	803	92	56	130	15

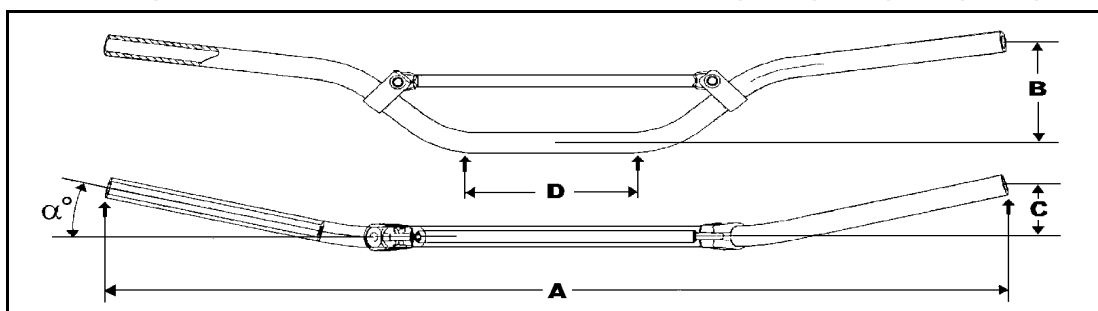



"DAMPER-CAP" VIBRATIONS REDUCERS

- CNC MACHINED FROM BILLET ALUMINUM
- TWO SIZE INSERTS WITH SPECIAL RUBBER, FOR Ø 12/14 MM AND Ø 17 MM INSIDE HOLES
- Ø 12/14 MM: FOR WRP "FAT-STREET" HANDLEBARS
- Ø 17 MM: FOR WRP "ALU-STREET" HANDLEBARS
- ANODIZED FINISH TO AVOID CORROSION



DAMPER-CAP / ALUMINUM VIBRATION DAMPERS		
APPLICATION	COLOUR	P/N
FOR Ø 12mm HANDLEBARS	BLACK	WD-2412-014
FOR Ø 12mm HANDLEBARS	RED	WD-2412-002
FOR Ø 12mm HANDLEBARS	BLUE	WD-2412-003
FOR Ø 17mm HANDLEBARS	BLACK	WD-2417-014
FOR Ø 17mm HANDLEBARS	RED	WD-2417-002
FOR Ø 17mm HANDLEBARS	BLUE	WD-2417-003

RISERS

- MADE TO RISE THE HANDLEBAR POSITION FROM 15 TO 30 MM
- CNC MACHINED FROM BILLET ALUMINUM



RISERS / HANDLEBARS RISER KITS		
APPLICATION	COLOUR	P/N
Ø 22 mm HANDLEBARS	SILVER	WDL-9011
Ø 28.6 mm OVERSIZE HANDLEBARS	SILVER	WDL-9012





“ALU-STREET” Ø 22 MM HANDLEBARS
 - MADE FROM 6082-T6 ALUMINUM ALLOY
 - ANODIZED SHOT-PEENED FINISH
 - LASER-ETCHED POSITION GRID

ALU-STREET / Ø 22 mm 6082-T6 ALUMINUM HANDLEBAR			
APPLICATION	BEND	COLOUR	P/N
UNIVERSAL	LOW - MONSTER 08>	RED	WD-2102-003
UNIVERSAL	LOW - MONSTER 08>	BLACK	WD-2102-014
UNIVERSAL	LOW - MONSTER 08>	SILVER	WD-2102-016
UNIVERSAL	LOW - MONSTER 08>	GOLD	WD-2102-017
UNIVERSAL	LOW	BLUE	WD-T2100-002
UNIVERSAL	LOW	RED	WD-T2100-003
UNIVERSAL	LOW	BLACK	WD-T2100-014
UNIVERSAL	LOW	SILVER	WD-T2100-016
UNIVERSAL	LOW	GOLD	WD-T2100-017
UNIVERSAL	MEDIUM	BLUE	WD-T2101-002
UNIVERSAL	MEDIUM	RED	WD-T2101-003
UNIVERSAL	MEDIUM	BLACK	WD-T2101-014
UNIVERSAL	MEDIUM	SILVER	WD-T2101-016
UNIVERSAL	MEDIUM	GOLD	WD-T2101-017

WRP STREET

- CONTROLS
- BRAKE PADS
- CHAINS
- CANOPIES / TENTS

STREET HANDLEBARS MEASURES / DIMENSIONS TABLE						
P/N	APPLICATION	A [mm]	B [mm]	C [mm]	D [mm]	α [°]
WD-T2100-...	ALU-STREET HANDLEBAR Ø 22 mm - LOW	725	75	95	130	23
WD-T2101-...	ALU-STREET HANDLEBAR Ø 22 mm - MEDIUM	715	110	105	130	27
WD-2102-...	ALU-STREET HANDLEBAR Ø 22 mm - MONSTER	760	0	85	100	25

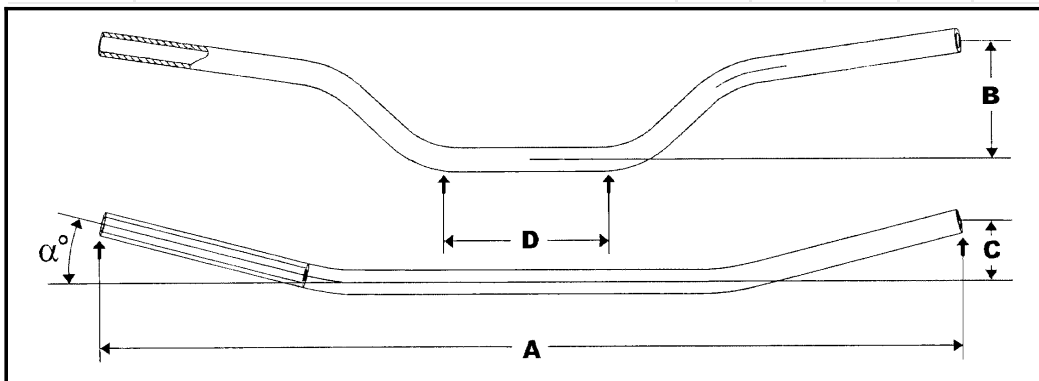

WRP OFF-ROAD

- CONTROLS
- BEARINGS & COMPONENTS
- BRAKE DISCS
- BRAKE PADS
- CHAINS
- SPROCKETS
- PROTECTIONS
- AIR & OIL FILTERS
- PLASTICS
- CANOPIES / TENTS





"PRO-MOUNT" ADAPTER MOUNTING KIT

- FOR INSTALLATION OF OVERSIZED BARS ON STOCK TRIPLE CLAMPS
- CNC MACHINED ALUMINUM
- COMPLETE WITH ALL MOUNTING BOLTS

PRO-MOUNT / OVERSIZE Ø 28.6 mm BAR ADAPTER MOUNTING KIT			
APPLICATION	COLOUR	P/N	
UNIVERSAL	SILVER	WD-9000	
UNIVERSAL	BLACK	WD-9000-014	



RISERS

- MADE TO RISE THE HANDLEBAR POSITION FROM 15 TO 30 MM
- CNC MACHINED FROM BILLET ALUMINUM

RISERS / HANDLEBARS RISER KITS			
APPLICATION	COLOUR	P/N	
Ø 22 mm HANDLEBARS	SILVER	WDL-9011	
Ø 28.6 mm OVERSIZE HANDLEBARS	SILVER	WDL-9012	



FAT-STREET / OVERSIZE TAPERED 7075-T6 ALUMINUM HANDLEBAR			
APPLICATION	BEND	COLOUR	P/N
UNIVERSAL	LOW	BLUE	WD-2200-002
UNIVERSAL	LOW	RED	WD-2200-003
UNIVERSAL	LOW	BLACK	WD-2200-014
UNIVERSAL	LOW	SILVER	WD-2200-016
UNIVERSAL	LOW	GOLD	WD-2200-017
UNIVERSAL	MEDIUM	BLUE	WD-2201-002
UNIVERSAL	MEDIUM	RED	WD-2201-003
UNIVERSAL	MEDIUM	BLACK	WD-2201-014
UNIVERSAL	MEDIUM	SILVER	WD-2201-016
UNIVERSAL	MEDIUM	GOLD	WD-2201-017

"FAT-STREET" OVERSIZE HANDLEBARS

- MADE FROM ULTRA STRONG AND LIGHTWEIGHT 7075-T6 ALUMINUM
- TAPER-WALL CONSTRUCTION
- 28,6 MM CLAMPING AREA DIAMETER
- ANODIZED SHOT-PEENED FINISH
- LASER-ETCHED POSITION GRID





FAT-STREET OVERSIZE HANDLEBARS MEASURES / DIMENSIONS TABLE

P/N	APPLICATION	A [mm]	B [mm]	C [mm]	D [mm]	α [°]
WD-2200-...	FAT-STREET HANDLEBAR Ø 28.6 mm - LOW	725	75	95	130	23
WD-2201-...	FAT-STREET HANDLEBAR Ø 28.6 mm - MEDIUM	715	110	105	130	27
WD-AM2200-...	FAT-STREET AMERICA HANDLEBAR Ø 28.6 mm - LOW	755	86	94	140	24
WD-AM2201-...	FAT-STREET AMERICA HANDLEBAR Ø 28.6 mm - MEDIUM	725	116	70	110	19

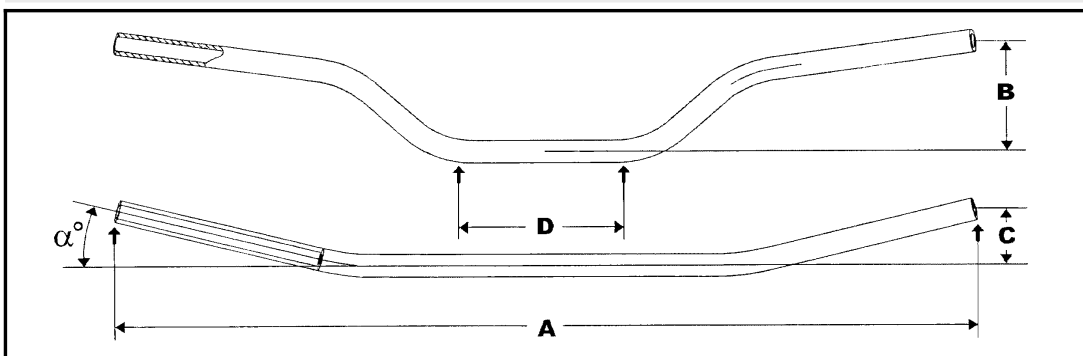

AMERICA SERIES

"FAT-STREET AMERICA" OVERSIZE HANDLEBARS

- MADE FROM ULTRA STRONG AND LIGHTWEIGHT ALUMINUM
- TAPER-WALL CONSTRUCTION
- 28,6 MM CLAMPING AREA DIAMETER
- ANODIZED SHOT-PEENED FINISH
- LASER-ETCHED POSITION GRID

FAT-STREET AMERICA / OVERSIZE Ø 28.6 mm TAPERED HANDLEBARS

APPLICATION	BEND	COLOUR	P/N
UNIVERSALE	LOW	BLACK	WD-AM2200-014
UNIVERSALE	LOW	RED	WD-AM2200-003
UNIVERSALE	LOW	GOLD	WD-AM2200-017
UNIVERSALE	MEDIUM	BLACK	WD-AM2201-014
UNIVERSALE	MEDIUM	RED	WD-AM2201-003
UNIVERSALE	MEDIUM	GOLD	WD-AM2201-017



WRP STREET
 CONTROLS
 BRAKE PADS
 CHAINS
 CANOPIES / TENTS

WRP OFF-ROAD
 CONTROLS
 BEARINGS & COMPONENTS
 BRAKE DISCS
 BRAKE PADS
 CHAINS
 SPROCKETS
 PROTECTIONS
 AIR & OIL FILTERS
 PLASTICS
 CANOPIES / TENTS



RISERS

- MADE TO RISE THE HANDLEBAR POSITION FROM 15 TO 30 MM
- CNC MACHINED FROM BILLET ALUMINUM
- MOUNTING BOLTS INCLUDED

RISERS / HANDLEBARS RISER KITS		
APPLICATION	COLOUR	P/N
Ø 22 mm HANDLEBARS	SILVER	WDL-9011
Ø 28.6 mm OVERSIZE HANDLEBARS	SILVER	WDL-9012



"PRO-MOUNT" ADAPTER MOUNTING KIT

- FOR INSTALLATION OF OVERSIZED BARS ON STOCK TRIPLE CLAMPS
- CNC MACHINED ALUMINUM
- COMPLETE WITH ALL MOUNTING BOLTS



PRO-MOUNT / OVERSIZE Ø 28.6 mm BAR ADAPTER MOUNTING KIT		
APPLICATION	COLOUR	P/N
UNIVERSAL	SILVER	WD-9000
UNIVERSAL	BLACK	WD-9000-014

"PRO-CLAMPS" Ø 28,6 HANDLEBARS MOUNTING CLAMPS

- FOR INSTALLATION OF HANDLEBARS ON BIKES WITH DETACHABLE BAR MOUNTS
- CNC MACHINED FROM 7075-T6 BILLET ALUMINUM
- ANODIZED FINISH
- COMPLETE WITH ALL MOUNTING BOLTS Ø 12 MM



PRO-CLAMPS / OVERSIZE Ø 28.6 mm BAR MOUNTING KIT			
APPLICATION	HEIGHT	COLOUR	P/N
DETACHABLE BAR MOUNTS W/ Ø 12 mm PIN	STD	BLACK	WDL-P9010
DETACHABLE BAR MOUNTS W/ Ø 12 mm PIN	HIGH (+10 mm)	BLACK	WDL-P9020



“PRO-THROTTLE“ THROTTLE TUBE

- FRICTION-LESS THROTTLE TUBE THANKS TO ITS INSERT WITH BEARING
- CNC MACHINED FROM BILLET ALUMINUM
- FOR HANDLEBARS WITH Ø 14 MM INSIDE HOLE (7075-T6 HANDLEBARS)
- FITS OEM JAPANESE AND KTM LATEST 4-STROKE BIKES

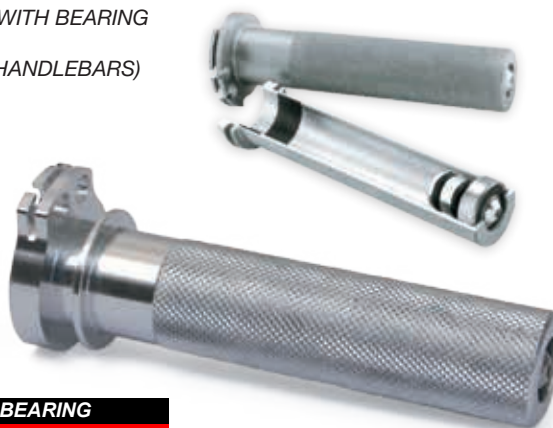

PRO-THROTTLE / ALUMINUM THROTTLE PIPE WITH BEARING		
APPLICATION	COLOUR	P/N
BETA RR 4T 400/450/525 05 >	ALUMINUM	WDL-1050
BMW G450X 08-11	ALUMINUM	WDL-1050
HONDA CRF / CRF-X 250/450 02 >	ALUMINUM	WDL-1010
HUSABERG ALL 4-STROKE 00 >	ALUMINUM	WDL-1050
HUSQVARNA ALL 4-STROKE 04 >	ALUMINUM	WDL-1050
KAWASAKI KX-F 250 04-05	ALUMINUM	WDL-1030
KAWASAKI KX-F 250/450 06 >	ALUMINUM	WDL-1020
KTM 4-ST SX-F / EXC 250>530 00 >	ALUMINUM	WDL-1050
SUZUKI RM-Z 250 05 >	ALUMINUM	WDL-1030
SUZUKI RM-Z 450 05 >	ALUMINUM	WDL-1020
YAMAHA YZF 250/400/426/450 98 >	ALUMINUM	WDL-1040
YAMAHA WRF 250/400/426/450 98 >	ALUMINUM	WDL-1030

WRP STREET

- CONTROLS
- BRAKE PADS
- CHAINS
- CANOPIES / TENTS

CONTROLS

- BEARINGS & COMPONENTS
- BRAKE DISCS
- BRAKE PADS
- CHAINS
- SPROCKETS
- PROTECTIONS
- AIR & OIL FILTERS
- PLASTICS
- CANOPIES / TENTS

OFF-ROAD GRIPS

- HALF-WAFFLE ERGONOMICALLY DESIGNED PATTERN
- SPECIAL BASE RUBBER COMPOUND FOR REDUCED VIBRATIONS AND LONGER WEAR
- TWO SINGLE DENSITY COMPOUNDS AVAILABLE: GREY (MEDIUM/SOFT), BLACK (MEDIUM/HARD)
- THREE PRE-MOLDED SAFETY WIRE GROOVES



WRP-GRIP / MX-ENDURO RUBBER GRIP			
APPLICATION	COMPOUND	COLOUR	P/N
UNIVERSAL	MEDIUM/SOFT	GREY	WDG-8010
UNIVERSAL	MEDIUM/HARD	BLACK	WDG-8020

WRP-DONUTS / NEOPRENE GRIP DONUTS		
APPLICATION	COLOUR	P/N
UNIVERSAL	WRP / BLACK	WDL-8000



LEVERS & PERCHES

- HIGH QUALITY COLD-FORGED ALUMINUM FOR MAXIMUM STRENGTH
- AVAILABLE FOR MOST POPULAR OFF-ROAD RACING BIKES
- O.E.M. REPLACEMENT DESIGN



PRO-BRAKE / FORGED ALUMINUM BRAKE LEVERS		
APPLICATION	COLOUR	P/N
BETA ENDURO 2st/4st 250-300-350-400-450-525 13 >	POLISHED	WDL-5010
BMW G 450X 08-11	POLISHED	WDL-5051
HONDA CR / CRF 85-125-250-450 96-06	POLISHED	WDL-5010
HONDA CR / CRF 125-150-250-450 07 >	POLISHED	WDL-5011
KAWASAKI KX 125-250-500 92-99	POLISHED	WDL-5020
KAWASAKI KX 65-85-125-250 00 >	POLISHED	WDL-5021
KAWASAKI KX-F 250-450 00-12	POLISHED	WDL-5021
KAWASAKI KX-F 250-450 13 >	POLISHED	WDL-5042
KTM SX / EXC 125> 00-05	POLISHED	WDL-5050
KTM SX / SX-F / EXC 125> 06-13	POLISHED	WDL-5051
KTM SX / SX-F / EXC 125> 14 >	POLISHED	WDL-5052
SUZUKI RM 125-250 96-03	POLISHED	WDL-5030
SUZUKI RM / RM-Z 65-85-125-250-450 04 >	POLISHED	WDL-5021
YAMAHA YZ / YZF / WR 80-125-250-400-426 96-00	POLISHED	WDL-5040
YAMAHA YZ 85-125-250 / YZF 450 / WRF 01-07	POLISHED	WDL-5041
YAMAHA YZF 250 01-06	POLISHED	WDL-5041
YAMAHA YZF 250 07 >	POLISHED	WDL-5042
YAMAHA YZ 85-125-250 / YZF 250-450 / WRF 08 >	POLISHED	WDL-5042

PRO-CLUTCH / FORGED ALUMINUM CLUTCH LEVERS		
APPLICATION	COLOUR	P/N
BETA ENDURO 2st/4st 250-300-350-400-450-525 13 >	POLISHED	WDL-6051
BMW G 450X 08-11	POLISHED	WDL-6011
HONDA CR / CRF 85-125-250-450 96-03	POLISHED	WDL-6010
HONDA CR / CRF 85-125-150-250-450 04 >	POLISHED	WDL-6011
KAWASAKI KX 65-80-85-125-250-500 92-07	POLISHED	WDL-6020
KAWASAKI KX 65-85 08 >	POLISHED	WDL-6020
KAWASAKI KX-F 250-450 05 >	POLISHED	WDL-6041
KTM SX / EXC (MAGURA PUMP) 00-06	POLISHED	WDL-6050
KTM SX / SX-F / EXC (BREMBO PUMP) 06 >	POLISHED	WDL-6051
SUZUKI RM 80-85-125-250 96-07	POLISHED	WDL-6030
SUZUKI RM-Z 250 05-06	POLISHED	WDL-6041
SUZUKI RM 85-125-250 / RM-Z 250 07 >	POLISHED	WDL-6020
SUZUKI RM-Z 450 05 >	POLISHED	WDL-6020
YAMAHA YZ / YZF / WR 80-125-250-400 96-99	POLISHED	WDL-6040
YAMAHA YZ 85-125-250 00 >	POLISHED	WDL-6041
YAMAHA YZF 250-426-450 00-08	POLISHED	WDL-6041
YAMAHA YZF 250-450 09 >	POLISHED	WDL-6042



PRO-BRACKET / FORGED ALUMINUM CLUTCH BRACKETS		
APPLICATION	COLOUR	P/N
HONDA CR 96-03	ALUMINUM	WDL-7010
KAWASAKI KX 96-08	ALUMINUM	WDL-7020
KAWASAKI KXF 450 09 >	ALUMINUM	WDL-7041
SUZUKI RM 93-08	ALUMINUM	WDL-7030
SUZUKI RM-Z 250 10 >	ALUMINUM	WDL-7020
SUZUKI RM-Z 450 09 >	ALUMINUM	WDL-7020
YAMAHA YZ 93-99	ALUMINUM	WDL-7040
YAMAHA YZ 00 >	ALUMINUM	WDL-7041
YAMAHA YZF 450 10 >	ALUMINUM	WDL-7041

DC-BRACKET / CASTED ALUMINUM CLUTCH BRACKETS		
APPLICATION	COLOUR	P/N
HONDA CR 04-08	ALUMINUM	WDL-7210
HONDA CRF 250 04-09	ALUMINUM	WDL-7211
HONDA CRF 250 10 >	ALUMINUM	WDL-7210
HONDA CRF 450 04-08	ALUMINUM	WDL-7211
HONDA CRF 450 09 >	ALUMINUM	WDL-7210
KAWASAKI KX-F 04	ALUMINUM	WDL-7220
SUZUKI RM-Z 250 04	ALUMINUM	WDL-7220
YAMAHA YZF 03-08	ALUMINUM	WDL-7241



FOLDING BRAKE & CLUTCH OFF-ROAD LEVERS

- IN CASE OF CRASH THESE LEVERS MOVE FORWARD AND DON'T BREAK
- ADJUSTABLE DISTANCE FROM HANDLEBAR
- CNC MACHINED FROM BILLET ALUMINUM WITH COLD-FORGED LEVER
- AVAILABLE FOR MOST POPULAR OFF-ROAD RACING BIKES
- ANODIZED FINISH



WRP STREET	CONTROLS
	BRAKE PADS
	CHAINS
	CANOPIES / TENTS

SX-PRO BRAKE / FRONT BRAKE FOLDING LEVERS		
APPLICATION	COLOUR	P/N
BETA ENDURO 2st/4st 250-300-350-400-450-525 13 >	TITANIUM	WDL-P5010
BMW G 450X 08-11	TITANIUM	WDL-P5050
HONDA CR / CRF 85-125-250-450 96-06	TITANIUM	WDL-P5010
HONDA CR / CRF 125-150-250-450 07 >	TITANIUM	WDL-P5011
KAWASAKI KX 00-13 / KX-F 00-12	TITANIUM	WDL-P5021
KAWASAKI KX-F 250/450 13 >	TITANIUM	WDL-P5042
KTM SX / EXC 00-05	TITANIUM	WDL-P5050
KTM SX / SX-F / EXC 06-13	TITANIUM	WDL-P5050
KTM SX / SX-F / EXC 14 >	TITANIUM	WDL-P5052
SUZUKI RM / RM-Z 04 >	TITANIUM	WDL-P5021
YAMAHA YZ / YZF 450 / WRF 01-07	TITANIUM	WDL-P5041
YAMAHA YZF 250 01-06	TITANIUM	WDL-P5041
YAMAHA YZF 250 07 >	TITANIUM	WDL-P5042
YAMAHA YZ / YZF 450 / WRF 08 >	TITANIUM	WDL-P5042

SX-PRO CLUTCH / CLUTCH FOLDING LEVERS		
APPLICATION	COLOUR	P/N
BETA ENDURO 2st/4st 250-300-350-400-450-525 13 >	TITANIUM	WDL-P6051
BMW G 450X 08-11	TITANIUM	WDL-P6011
HONDA CR / CRF 85-125-250-450 96-03	TITANIUM	WDL-P6010
HONDA CR / CRF 85-125-150-250-450 04 >	TITANIUM	WDL-P6011
KAWASAKI KX 92-07	TITANIUM	WDL-P6020
KAWASAKI KX-F 250 / 450 05 >	TITANIUM	WDL-P6041
KTM SX / EXC (MAGURA PUMP) 00-06	TITANIUM	WDL-P6050
KTM SX / SX-F / EXC (BREMBO PUMP) 06 >	TITANIUM	WDL-P6051
SUZUKI RM-Z 250 05-06	TITANIUM	WDL-P6041
SUZUKI RM-Z 250 07 >	TITANIUM	WDL-P6020
SUZUKI RM-Z 450 05 >	TITANIUM	WDL-P6020
YAMAHA YZ / YZF / WR 80-125-250-400 96-99	TITANIUM	WDL-P6040
YAMAHA YZ 85-125-250 00 >	TITANIUM	WDL-P6041
YAMAHA YZF 250-426-450 00-08	TITANIUM	WDL-P6041
YAMAHA YZF 250-450 09 >	TITANIUM	WDL-P6042

WRP OFF-ROAD	CONTROLS
	BEARINGS & COMPONENTS
	BRAKE DISCS
	BRAKE PADS
	CHAINS
	SPROCKETS
	PROTECTIONS
	AIR & OIL FILTERS
	PLASTICS
	CANOPIES / TENTS





LAUNCH CONTROLS

- STARTING DEVICE FOR BETTER PERFORMANCE
- ENHANCED TRACTION BY PRE-LOADING THE FORK
- CNC MACHINED FROM BILLET ALUMINUM
- ANODIZED FINISH TO AVOID CORROSION

PRO-LAUNCH / ALUMINUM FORK PRE-LOADING STARTING DEVICE		
APPLICATION	COLOUR	P/N
HONDA CR 80/85 / CRF 150	BLACK/RED	WDLC-302
HONDA CR / CR-F 250/450/450X	BLACK/RED	WDLC-403
KAWASAKI KX 80/85/100	BLACK/RED	WDLC-304
KAWASAKI KX 125/250 04-09 / KX-F 250 04-05	BLACK/RED	WDLC-400
KAWASAKI KX-F 250/450 07 >	BLACK/RED	WDLC-407
KTM SX 65 00 >	BLACK/RED	WDLC-410
KTM SX 85 03 >	BLACK/RED	WDLC-409
KTM SX 125/200/250 / SX-F 02 >	BLACK/RED	WDLC-406
SUZUKI RM 85	BLACK/RED	WDLC-300
SUZUKI RM 125 01-09 / RM 250 04-06	BLACK/RED	WDLC-400
SUZUKI RM-Z 250 04-06 / RM-Z 450 05-06	BLACK/RED	WDLC-400
SUZUKI RM-Z 250/450 07 >	BLACK/RED	WDLC-412
YAMAHA YZ 80 93-01 / YZ 85 02-09	BLACK/RED	WDLC-305
YAMAHA YZ / YZF 98-04	BLACK/RED	WDLC-405
YAMAHA YZ / YZF 05-07	BLACK/RED	WDLC-408
YAMAHA YZ / YZF 08 >	BLACK/RED	WDLC-411

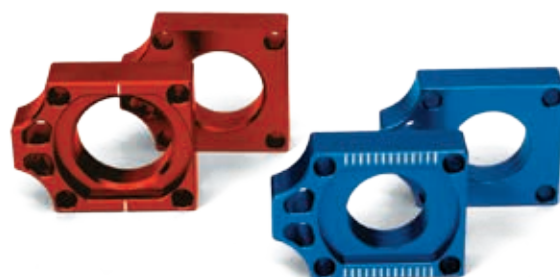
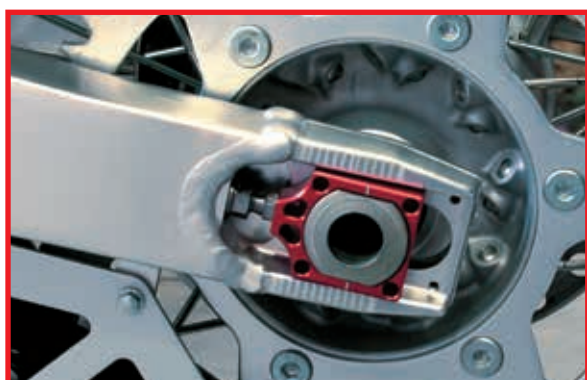

"PRO-SPACERS" AXLE BLOCKS

- CNC MACHINED FROM BILLET ALUMINUM
- REVERSIBLE FOR QUICK SPROCKET CHANGES
- ELIMINATES OVER EXTENDED ADJUSTMENT BOLTS
- ANODIZED FINISH TO AVOID CORROSION

PRO-SPACER / CNC MACHINED ALUMINUM REAR AXLE BLOCK SPACERS		
APPLICATION	COLOUR	P/N
HONDA CR / CRF 125/250/450 99-08	RED	WDL-2010
HONDA CRF 250/450 09 >	RED	WDL-2011
KAWASAKI KX / KX-F 125/250/450 04 >	RED	WDL-2020
SUZUKI RM-Z 250 07 >	RED	WDL-2030
SUZUKI RM-Z 450 05 >	RED	WDL-2030
YAMAHA YZ 125/250 01 >	BLUE	WDL-2040
YAMAHA YZF 01-08	BLUE	WDL-2040
YAMAHA YZF 09 >	BLUE	WDL-2041



PRO-PEG / STAINLESS STEEL MX-ENDURO FOOT PEGS		
APPLICATION	COLOUR	P/N
GAS GAS EC / XC / MX 02-07	STEEL	WDP-0140
HONDA CR 125/250/500 95-99	STEEL	WDP-0140
HONDA CR / CRF 125/250/450 02 >	STEEL	WDP-0111
KAWASAKI KX / KX-F 125/250/450 03-04	STEEL	WDP-0160
KTM SX / EXC 125> 98 >	STEEL	WDP-0150
SUZUKI RM 125/250 91-02	STEEL	WDP-0130
SUZUKI DR-Z 00-06	STEEL	WDP-0130
SUZUKI RM-Z 250 04	STEEL	WDP-0160
YAMAHA YZ / YZ-F / WR-F 125/250/450 99 >	STEEL	WDP-0140



STEEL FOOTPEGS
- CASTED HEAT-TREATED STEEL



ALU-PEG / 7075-T6 ALUMINUM MX-ENDURO FOOT PEGS		
APPLICATION	COLOUR	P/N
GAS GAS EC / XC / MX 02-07	BLACK	WDP-0240A
HONDA CR 125/250/500 95-99	BLACK	WDP-0240A
HONDA CR / CRF 125/250/450 02 >	BLACK	WDP-0210A
KAWASAKI KX-F 250 06 >	BLACK	WDP-0270A
KAWASAKI KX-F 450 07 >	BLACK	WDP-0270A
KTM SX / SX-F / EXC 125> 98 >	BLACK	WDP-0250A
SUZUKI RM-Z 250 07-09	BLACK	WDP-0280A
SUZUKI RM-Z 250 10 >	BLACK	WDP-0290A
SUZUKI RM-Z 450 05-07	BLACK	WDP-0280A
SUZUKI RM-Z 450 08 >	BLACK	WDP-0290A
YAMAHA YZ / YZ-F / WR-F 125/250/450 99 >	BLACK	WDP-0240A

ALUMINUM FOOTPEGS
- CNC MACHINED FROM BILLET 7075-T6 ALUMINUM
- WIDE SUPPORT AREA TO IMPROVE RIDER BALANCE
- ANODIZED FINISH TO AVOID CORROSION



WRP STREET

- CONTROLS
- BRAKE PADS
- CHAINS
- CANOPIES / TENTS

WRP OFF-ROAD

- CONTROLS
- BEARINGS & COMPONENTS
- BRAKE DISCS
- BRAKE PADS
- CHAINS
- SPROCKETS
- PROTECTIONS
- AIR & OIL FILTERS
- PLASTICS
- CANOPIES / TENTS



PRO SHIFTER

- HIGH QUALITY COLD-FORGED ALUMINUM FOR MAXIMUM STRENGTH
- AVAILABLE FOR THE MOST POPULAR OFF-ROAD RACING BIKES
- BLACK ANODIZED FINISH
- O.E.M. REPLACEMENT DESIGN

PRO SHIFTER - FORGED ALUMINUM MX-ENDURO SHIFTER LEVER

APPLICATION	COLOUR	P/N
HONDA CRF 250 06 >	BLACK	WDL-FS010
HONDA CRF 450 02 >	BLACK	WDL-FS011
KAWASAKI KX-F 250 06 >	BLACK	WDL-FS020
KAWASAKI KX-F 450 06 >	BLACK	WDL-FS021
KTM 2-stroke 125> SX / EXC 00 >	BLACK	WDL-FS050
KTM 4-stroke 250> SX-F / EXC / EXC-F 05 >	BLACK	WDL-FS051
SUZUKI RM-Z 250 07 >	BLACK	WDL-FS030
SUZUKI RM-Z 450 08 >	BLACK	WDL-FS031
YAMAHA YZ 125/250 05>	BLACK	WDL-FS039
YAMAHA YZ-F 250 06-13	BLACK	WDL-FS040
YAMAHA YZ-F 450 06-13	BLACK	WDL-FS041
YAMAHA YZ-F 250/450 14>	BLACK	WDL-FS042

PRO REAR - FORGED ALUMINUM MX-ENDURO REAR BRAKE PEDAL

APPLICATION	COLOUR	P/N
HONDA CRF 250 04 >	BLACK	WDL-FB010
HONDA CRF 450 02-16	BLACK	WDL-FB011
KAWASAKI KX-F 250 05 >	BLACK	WDL-FB020
KAWASAKI KX-F 450 06 >	BLACK	WDL-FB021
KTM SX / SX-F / EXC / EXC-F 03 >	BLACK	WDL-FB050
SUZUKI RM-Z 250 07 >	BLACK	WDL-FB030
SUZUKI RM-Z 450 08 >	BLACK	WDL-FB031
YAMAHA YZ-F 250 10 >	BLACK	WDL-FB040
YAMAHA YZ-F 450 10 >	BLACK	WDL-FB041



PRO REAR

- HIGH QUALITY COLD-FORGED ALUMINUM ARM WITH CNC MACHINED TIP
- AVAILABLE FOR THE MOST POPULAR OFF-ROAD RACING BIKES
- BLACK ANODIZED FINISH
- O.E.M. REPLACEMENT DESIGN
- PEDAL SAVER CABLE INCLUDED



WRP COMPONENTS - THE COMPLETE REPAIR & REBUILD LINE

- LINKAGE REPAIR KITS
- SWING-ARM REPAIR KITS
- WHEEL BEARINGS & SEAL KITS
- UPPER / LOWER SHOCK BEARING & SEAL KITS
- FORK & DUST SEAL KITS
- FORK BUSHING KITS
- COUNTERSHAFT REBUILD KITS



WRP STREET	CONTROLS
	BRAKE PADS
	CHAINS
	CANOPIES / TENTS

WRP OFF-ROAD	CONTROLS
	BEARINGS & COMPONENTS
	BRAKE DISCS
	BRAKE PADS
	CHAINS
	SPROCKETS
	PROTECTIONS
	AIR & OIL FILTERS
	PLASTICS
	CANOPIES / TENTS

**FOR APPLICATIONS
SEE PRICE LIST**



TAPERED STEERING KIT

- THE STEERING REPAIR SETS COME AS PACKAGE INCLUDING ALL PARTS YOU NEED
- HEAVY-DUTY TAPERED ROLLER BEARINGS
- MIX AND MATCH BEARINGS/SEALS FOR FRONT-END CONVERSIONS
- O.E.M. REPLACEMENT



FORK & DUST SEAL KIT

- SEAL PROFILE ENGINEERED TO CREATE EQUAL PRESSURE IN EACH SEAL LIP
- PATENTED COEFFICIENT OF FRICTION UP TO 3-TIME LESS THEN O.E.M. SEAL MATERIAL
- TRIPLE LIP SEAL DESIGN
- DYNO TESTED TO LAST 3 TO 4-TIME LONGER THAN O.E.M. SEALS
- O.E.M. REPLACEMENT



WHEEL BEARING & SEAL KIT

- THE WHEEL & SEAL SETS COME AS PACKAGE INCLUDING ALL PARTS YOU NEED
- PRECISION HIGH-SPEED BEARINGS MANUFACTURED TO ABEC3 STANDARD SR BEARINGS
- HIGH-PERFORMANCE RUST AND OXIDATION INIBITOR CHEVRON SRI GREASE
- DOUBLE LIP SEAL TYPE TC
- O.E.M. REPLACEMENT



UPPER / LOWER SHOCK BEARING AND SEAL KIT

- THE STEERING SETS COME AS PACKAGE INCLUDING ALL PARTS YOU NEED
- 52100 BEARING STEEL, HARDENED AND PRECISION GROUND
- O.E.M. STYLE CLIP SEALS
- FULL COMPLIMENT NEEDLE BEARING
- CASE HARDENED AND PLATED BUSHINGS
- SPHERICAL BEARING



LINKAGE REPAIR KIT

- THE LINKAGE REPAIR SETS COME AS PACKAGE INCLUDING ALL PARTS YOU NEED
- BUSHINGS: 52100 BEARING STEEL, CASE HARDENED AND PRECISION GROUND
- LOWER SHOCK BEARING KIT INCLUDED
- F52100 NEEDLE BEARINGS STEEL NT NEEDLE BEARING



WRP STREET

- CONTROLS
- BRAKE PADS
- CHAINS
- CANOPIES / TENTS

WRP OFF-ROAD

- CONTROLS
- BEARINGS & COMPONENTS
- BRAKE DISCS
- BRAKE PADS
- CHAINS
- SPROCKETS
- PROTECTIONS
- AIR & OIL FILTERS
- PLASTICS
- CANOPIES / TENTS



MADE IN EUROPE



"WAVE" OFF-ROAD BRAKE DISCS						
MAKE / MODEL	CC	YEAR	FRONT	FRONT OVERSIZE Ø270	CALIPER ADAPT. Ø270	REAR
GAS GAS						
EC / MC	125	96-11				WCB-MPKT03-22
EC / MC / EC-F RACING	250	96-14				WCB-MPKT03-22
EC / MC / EC-F RACING	300	96-14				WCB-MPKT03-22
EC / MC / FSE	400	02				WCB-MPKT03-22
EC / MC / PAMPERA	400	06-07				WCB-MPKT03-22
EC / MC / FSE	450	03-06				WCB-MPKT03-22
EC F	450	13-14				WCB-MPKT03-22
FSR	450	07				WCB-MPKT03-22
HONDA						
CR / CRE	125	98-01	WCB-MAHO25-24			
CR / CRE	125	02-03	WCB-MAHO25-24			WCB-MPHO38-24
CR / CRE	125	04-08	WCB-MAHO25-24	WCB-MAHO25F-27	WCB-0079	WCB-MPHO38-24
CR / CRE	250	97-01	WCB-MAHO25-24			
CR / CRE	250	02-03	WCB-MAHO25-24			WCB-MPHO38-24
CR / CRE	250	04-09	WCB-MAHO25-24	WCB-MAHO25F-27	WCB-0079	WCB-MPHO38-24
CRF / CRF-X	250	04-14	WCB-MAHO25-24	WCB-MAHO25F-27	WCB-0079	WCB-MPHO38-24
CRF	250	15-17	WCB-MAHO25-26	WCB-MAHO25F-27	WCB-0079	WCB-MPHO38-24
CRF	450	02-03	WCB-MAHO25-24			WCB-MPHO38-24
CRF / CRF-X	450	04-14	WCB-MAHO25-24	WCB-MAHO25F-27	WCB-0079	WCB-MPHO38-24
CRF / CRF-RX	450	15-17	WCB-MAHO25-26	WCB-MAHO25F-27	WCB-0079	WCB-MPHO38-24
CR / CRE	500	95-01	WCB-MAHO25-24			
HUSABERG						
FE / FE	250	13-14	WCB-MAKT02-26	WCB-MAKT02F-27	WCB-4008	WCB-MPKT03-22
TE	300	11-14	WCB-MAKT02-26	WCB-MAKT02F-27	WCB-4008	WCB-MPKT03-22
FE	350	13-14	WCB-MAKT02-26	WCB-MAKT02F-27	WCB-4008	WCB-MPKT03-22
FE	390	10-12	WCB-MAKT02-26	WCB-MAKT02F-27	WCB-4008	WCB-MPKT03-22
FE / FE-E / FS	400	00-03	WCB-MAKT02-26	WCB-MAKT02F-27	WCB-0068	WCB-MPKT03-22
FE / FX	450	10-14	WCB-MAKT02-26	WCB-MAKT02F-27	WCB-4008	WCB-MPKT03-22
FC / FE / FE-E	501	00-04	WCB-MAKT02-26	WCB-MAKT02F-27	WCB-0068	WCB-MPKT03-22
FE	510	13-14	WCB-MAKT02-26	WCB-MAKT02F-27	WCB-4008	WCB-MPKT03-22
FC	550	01-05	WCB-MAKT02-26	WCB-MAKT02F-27	WCB-0068	WCB-MPKT03-22
FE-E	550	04-08	WCB-MAKT02-26	WCB-MAKT02F-27	WCB-0068	WCB-MPKT03-22
FE	570	10-12	WCB-MAKT02-26	WCB-MAKT02F-27	WCB-4008	WCB-MPKT03-22
FC / FE / FE SM	600	00-03	WCB-MAKT02-26	WCB-MAKT02F-27	WCB-0068	WCB-MPKT03-22
FE E / FS / FX	650	01-08		WCB-MAKT02F-27	WCB-0068	WCB-MPKT03-22
HUSQVARNA						
			FRONT Ø OEM			REAR
TC / TE	125	14-17	WCB-MAKT02-26	WCB-MAKT02F-27	WCB-4008	WCB-MPKT03-22
FC / FE	250	14-17	WCB-MAKT02-26	WCB-MAKT02F-27	WCB-4008	WCB-MPKT03-22
TC / TE	250	14-17	WCB-MAKT02-26	WCB-MAKT02F-27	WCB-4008	WCB-MPKT03-22
TE	300	14-17	WCB-MAKT02-26	WCB-MAKT02F-27	WCB-4008	WCB-MPKT03-22
FC / FE	350	14-17	WCB-MAKT02-26	WCB-MAKT02F-27	WCB-4008	WCB-MPKT03-22
FC / FE	450	14-17	WCB-MAKT02-26	WCB-MAKT02F-27	WCB-4008	WCB-MPKT03-22
FE	501	15-17	WCB-MAKT02-26	WCB-MAKT02F-27	WCB-4008	WCB-MPKT03-22
FE	510	2014	WCB-MAKT02-26	WCB-MAKT02F-27	WCB-4008	WCB-MPKT03-22

BRAKE DISCS

- CAD-CAM LASER CUT FROM HIGH-CARBON AISI 420 STAINLESS STEEL
- HEAT-TREATED AND LAP-GROUND FOR PARALLEL AND PERFECT FLAT SURFACE
- PERFECT HEAT DISSIPATION THANKS TO ITS IRREGULAR OUTLINE
- PAD/DISC IMPROVED CONTACT SURFACE
- CONSTANT PADS CLEANING
- PROMPTER BRAKING RESPONSE



WRP STREET

- CONTROLS
- BRAKE PADS
- CHAINS
- CANOPIES / TENTS

WRP OFF-ROAD

- CONTROLS
- BEARINGS & COMPONENTS
- BRAKE DISCS
- BRAKE PADS
- CHAINS
- SPROCKETS
- PROTECTIONS
- AIR & OIL FILTERS
- PLASTICS
- CANOPIES / TENTS



"WAVE" OFF-ROAD BRAKE DISCS						
MAKE / MODEL	CC	YEAR	FRONT	FRONT OVERSIZE Ø270	CALIPER ADAPT. Ø270	REAR
KAWASAKI						
KX	125	06-08	WCB-MAKW39-25	WCB-MAKW39F-27	WCB-0002	WCB-MPKW35-24
KX	250	06-08	WCB-MAKW39-25	WCB-MAKW39F-27	WCB-0002	WCB-MPKW35-24
KX F	250	06-14	WCB-MAKW39-25	WCB-MAKW39F-27	WCB-0002	WCB-MPKW35-24
KX F	250	15-17	WCB-MAKW39-27	WCB-MAKW39F-27		WCB-MPKW35-24
KLX R	450	07-16	WCB-MAKW39-25	WCB-MAKW39F-27	WCB-0002	WCB-MPKW35-24
KX F	450	06-14	WCB-MAKW39-25	WCB-MAKW39F-27	WCB-0002	WCB-MPKW35-24
KX F	450	15-17	WCB-MAKW39-27	WCB-MAKW39F-27		WCB-MPKW35-24
KTM						
SX	85	03-10	WCB-MAKT07-16			WCB-MPKT07-16
SX	85	11-12	WCB-MAKT07-16			
SX	105	04-08	WCB-MAKT07-16			WCB-MPKT07-16
EXC / SX / EXC-F / EXC	>	93-08	WCB-MAKT02-26	WCB-MAKT02F-27	WCB-0068	WCB-MPKT03-22
EXC / SX / EXC-F / EXC	>	09-10	WCB-MAKT02-26	WCB-MAKT02F-27	WCB-4008	WCB-MPKT03-22
EXC / EXC-F	>	11-17	WCB-MAKT02-26	WCB-MAKT02F-27	WCB-4008	WCB-MPKT03-22
SX / SX-F	>	11-15	WCB-MAKT02-26	WCB-MAKT02F-27	WCB-4008	WCB-MPKT03-22
SX-F	>	16-17	WCB-MAKT02-26	WCB-MAKT02F-27	WCB-4008	WCB-MPKT03-22
XC / XC-F / SX-F	>	93-08	WCB-MAKT02-26	WCB-MAKT02F-27	WCB-0068	WCB-MPKT03-22
XC / XC-F / SX	>	09-17	WCB-MAKT02-26	WCB-MAKT02F-27	WCB-4008	WCB-MPKT03-22
SUZUKI						
RM	125	96-99	WCB-MASZ01-25	WCB-MASZ01F-27	WCB-0002	
RM	125	00-08	WCB-MASZ01-25	WCB-MASZ01F-27	WCB-0002	
RM	250	96-99	WCB-MASZ01-25	WCB-MASZ01F-27	WCB-0002	
RM	250	00-08	WCB-MASZ01-25	WCB-MASZ01F-27	WCB-0002	
RM Z	250	07-17	WCB-MASZ37-25	WCB-MASZ37F-27	WCB-0002	WCB-MPSZ37-24
RM Z	450	05-17	WCB-MASZ37-25	WCB-MASZ37F-27	WCB-0002	WCB-MPSZ37-24
DR Z	400	00-09	WCB-MASZ01-25	WCB-MASZ01F-27	WCB-0002	

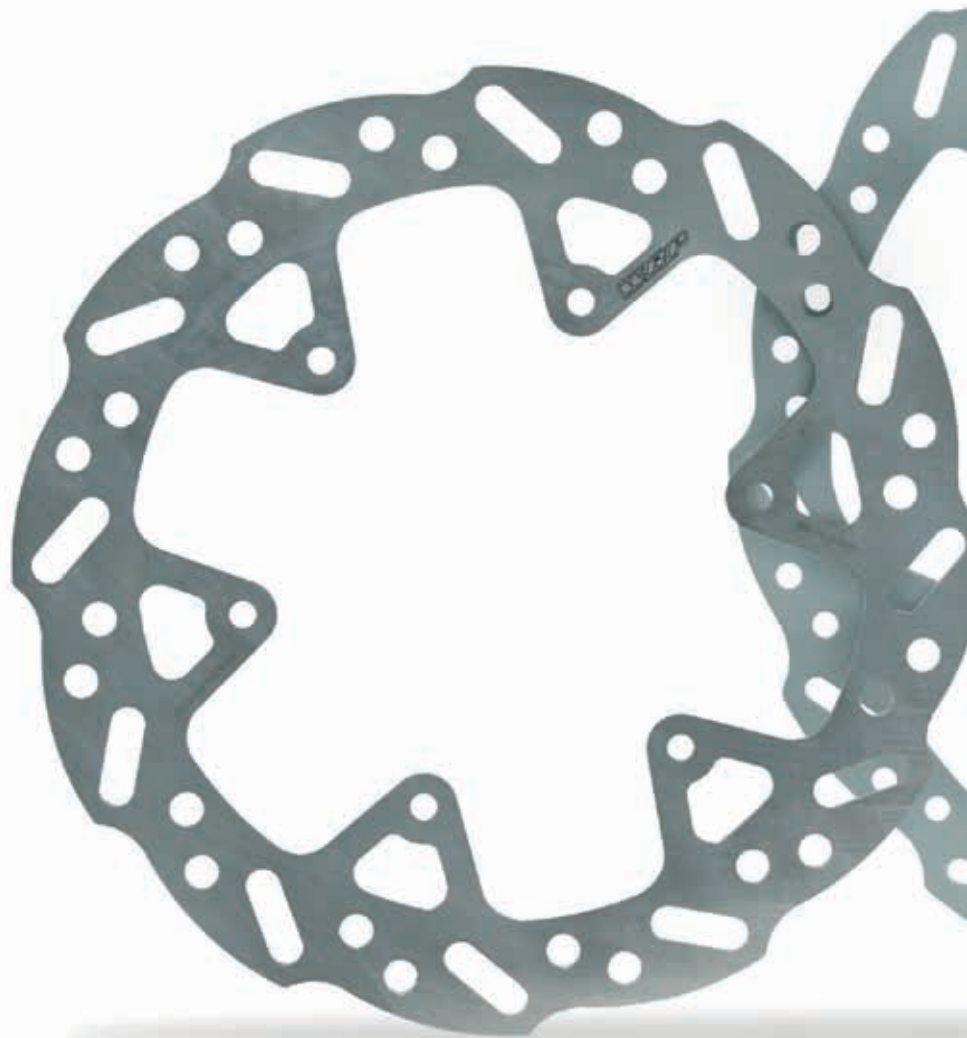



"WAVE" OFF-ROAD BRAKE DISCS						
MAKE / MODEL	CC	YEAR	FRONT	FRONT OVERSIZE Ø270	CALIPER ADAPT. Ø270	REAR
YAMAHA						
YZ / WR	125	01	WCB-MASZ01-25	WCB-MASZ01F-27	WCB-0004	
YZ / WR	125	02-07	WCB-MASZ01-25	WCB-MASZ01F-27	WCB-0004	WCB-MPYA29-24
YZ	125	08-16	WCB-MAYA01-25	WCB-MAYA01F-27	WCB-0078	WCB-MPYA29-24
YZ	125	2017	WCB-MAYA01-27	WCB-MAYA01F-27		WCB-MPYA29-24
YZ / WR	250	01	WCB-MASZ01-25	WCB-MASZ01F-27	WCB-0004	
YZ / WR	250	02-07	WCB-MASZ01-25	WCB-MASZ01F-27	WCB-0004	WCB-MPYA29-24
YZ	250	08-16	WCB-MAYA01-25	WCB-MAYA01F-27	WCB-0078	WCB-MPYA29-24
YZF / WRF	250	01	WCB-MASZ01-25	WCB-MASZ01F-27	WCB-0004	
YZF / WRF	250	02-06	WCB-MASZ01-25	WCB-MASZ01F-27	WCB-0004	WCB-MPYA29-24
YZF	250	07-15	WCB-MAYA01-25	WCB-MAYA01F-27	WCB-0078	WCB-MPYA29-24
YZF	250	16-17	WCB-MAYA01-27	WCB-MAYA01F-27		WCB-MPYA29-24
WRF	250	06-16	WCB-MASZ01-25	WCB-MASZ01F-27	WCB-0004	WCB-MPYA29-24
WRF	250	2017	WCB-MAYA01-27	WCB-MAYA01F-27		WCB-MPYA29-24
YZF / WRF	426	01	WCB-MASZ01-25	WCB-MASZ01F-27	WCB-0004	
YZF / WRF	426	02	WCB-MASZ01-25	WCB-MASZ01F-27	WCB-0004	WCB-MPYA29-24
YZF / WRF	450	03-07	WCB-MASZ01-25	WCB-MASZ01F-27	WCB-0004	WCB-MPYA29-24
YZF	450	08-15	WCB-MAYA01-25	WCB-MAYA01F-27	WCB-0078	WCB-MPYA29-24
YZF	450	16-17	WCB-MAYA01-27	WCB-MAYA01F-27		WCB-MPYA29-24
WRF	450	08-15	WCB-MASZ01-25	WCB-MASZ01F-27	WCB-0004	WCB-MPYA29-24
WRF	450	16-17	WCB-MAYA01-27	WCB-MAYA01F-27		WCB-MPYA29-24

WRP STREET	CONTROLS
	BRAKE PADS
	CHAINS
	CANOPIES / TENTS

WRP OFF-ROAD	CONTROLS
	BEARINGS & COMPONENTS
	BRAKE DISCS
	BRAKE PADS
	CHAINS
	SPROCKETS
	PROTECTIONS
	AIR & OIL FILTERS
	PLASTICS
	CANOPIES / TENTS

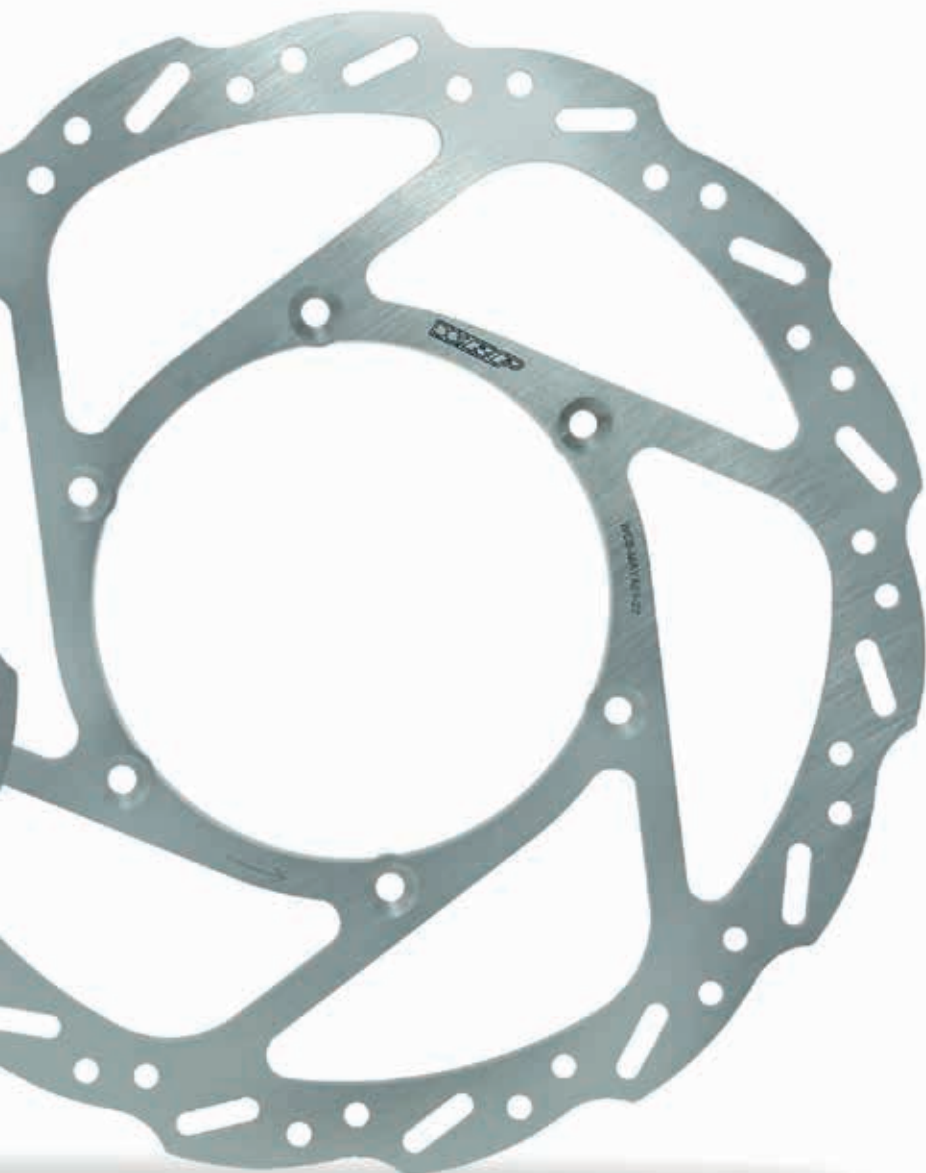

MADE IN EUROPE



**FOR APPLICATIONS
SEE PRICE LIST**

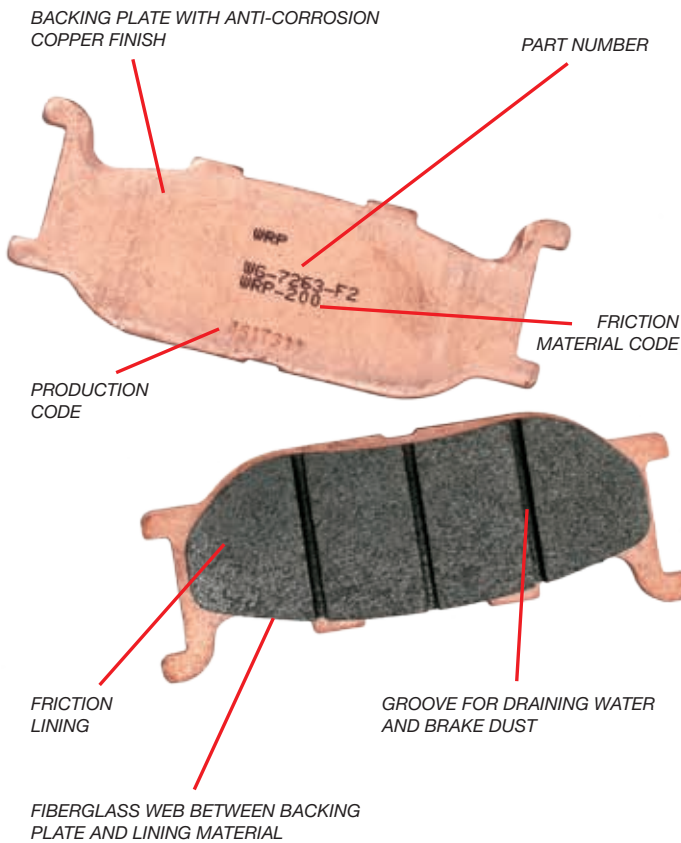

STANDARD & SINTERED BRAKE PADS

- DESIGNED FOR FLAWLESS PERFORMANCE ON ALL STREET BIKES, OFF-ROAD BIKES AND ATV
- HIGH FRICTION MATERIALS TO PROVIDE THE ULTIMATE IN STOPPING POWER

RACING SINTERED BRAKE PADS

- HIGH PERFORMANCE RACING PADS, TESTED AND USED BY PROFESSIONAL RACE TEAMS ON GP TRACKS
- DELIVER OUTSTANDING PERFORMANCE THANKS TO AN EXTREME COEFFICIENT OF FRICTION

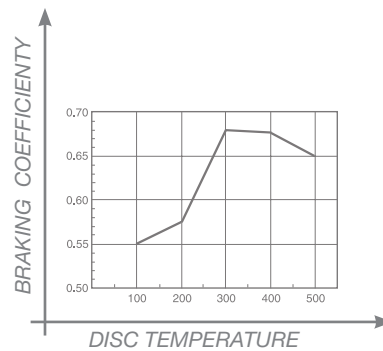

WRP STREET

- CONTROLS
- BRAKE PADS
- CHAINS
- CANOPIES / TENTS

WRP OFF-ROAD

- CONTROLS
- BEARINGS & COMPONENTS
- BRAKE DISCS
- BRAKE PADS
- CHAINS
- SPROCKETS
- PROTECTIONS
- AIR & OIL FILTERS
- PLASTICS
- CANOPIES / TENTS

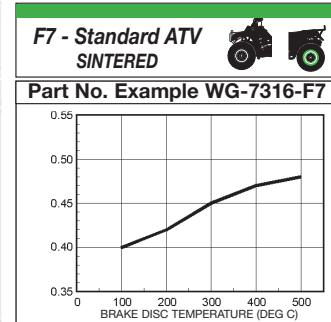
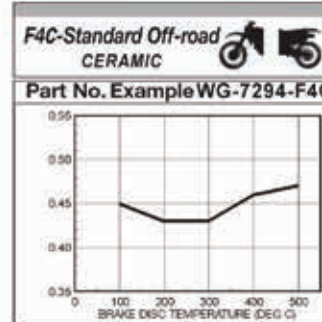
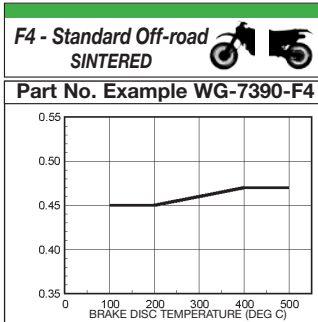
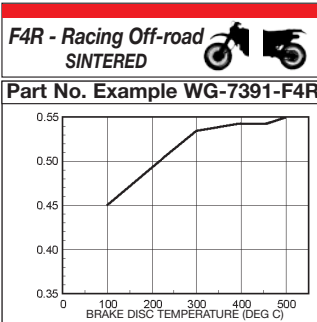

A compound that provides great feel and maximum performance under racing terms. Suitable for OE cast iron and stainless steel discs.

Formulation for abrasive environment condition without losing its good performance. Mainly suitable for OE stainless steel discs.

For every day off-road riding, for smooth and powerful performance. Suggested for use in dry conditions. Suitable for OE cast iron and stainless steel discs.

The best compound to achieve superior compatibility in relation to performance and pad/disc wear on ATVs, with OE cast iron and stainless steel discs.



Stefan Bradl
2011 Moto2 GP World Champion



Tom Luthi - Moto2 GP



Sylvain Barrier
2012-13 STK 1000 World Champion

- WRP STREET
- CONTROLS
- BRAKE PADS
- CHAINS
- CANOPIES / TENTS



Marco Melandri
Chaz Davies
2013 SBK BMW Factory Team

- WRP OFF-ROAD
- CONTROLS
- BEARINGS & COMPONENTS
- BRAKE DISCS
- BRAKE PADS
- CHAINS
- SPROCKETS
- PROTECTIONS
- AIR & OIL FILTERS
- PLASTICS
- CANOPIES / TENTS



Sam Lowes - Mofoto2 GP





BACKING PLATE WITH ANTI-CORROSION COPPER FINISH

PART NUMBER

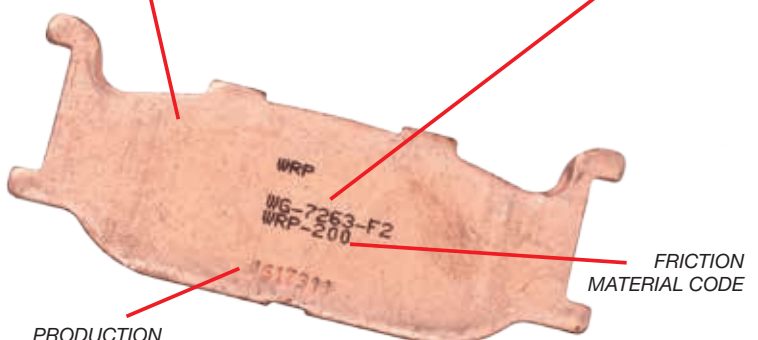

FRICTION MATERIAL CODE

PRODUCTION CODE

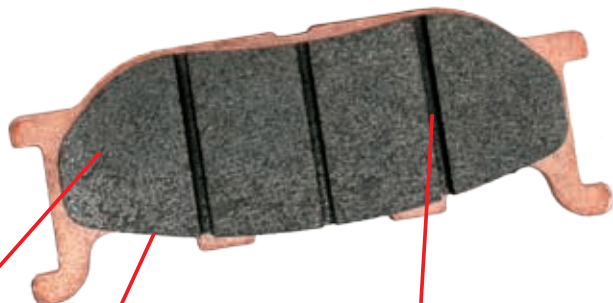

FRICTION LINING

GROOVE FOR DRAINING WATER AND BRAKE DUST

FIBERGLASS WEB BETWEEN BACKING PLATE AND LINING MATERIAL

STANDARD & SINTERED BRAKE PADS

- DESIGNED FOR FLAWLESS PERFORMANCE ON ALL STREET BIKES, OFF-ROAD BIKES AND ATV
- HIGH FRICTION MATERIALS TO PROVIDE THE ULTIMATE IN STOPPING POWER

RACING SINTERED BRAKE PADS

- HIGH PERFORMANCE RACING PADS, TESTED AND USED BY PROFESSIONAL RACE TEAMS ON GP TRACKS
- DELIVER OUTSTANDING PERFORMANCE THANKS TO AN EXTREME COEFFICIENT OF FRICTION

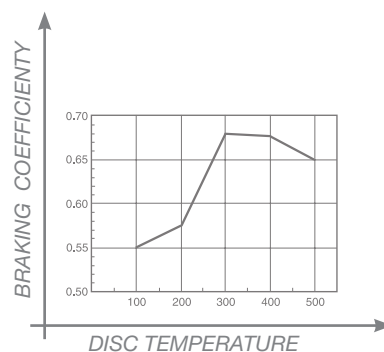

**FOR APPLICATIONS
SEE PRICE LIST**



**F8 - Maxi scooter
SINTERED**



Part No. Example WG-7238-F8

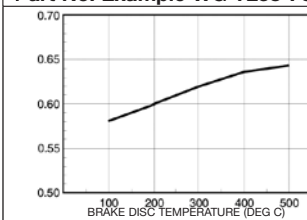

Specially developed brake pads for maxi scooters. Increased stopping power and longevity, the perfect upgrade from OE material. Suitable for iron and stainless steel discs.



F1R - Road Racing
CARBON COMPOSITE

Part No. Example WG-7306-F1R

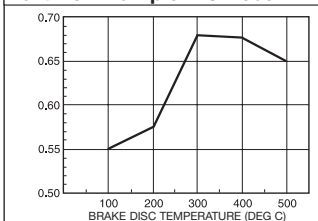

Innovative racing pad composition for utmost thermal stability and longevity. Suitable for OE Standard/Racing stainless steel brake discs.



F9R - Road Racing
SINTERED

Part No. Example WG-7388-F9R

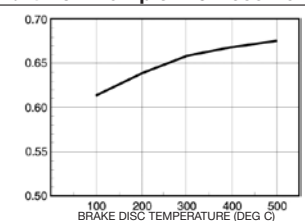

Extreme temperature stability, longevity and performance compound for Endurance, Racing, Superstock & Supersport brake calipers. Suitable for stainless steel discs.



F5R - Road Racing
SINTERED

Part No. Example WG-7306-F5R

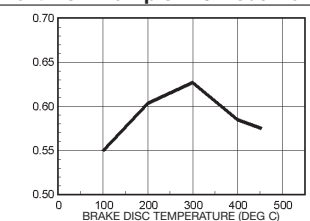

Provides top performance at hot and cold braking conditions. Suitable for OE cast iron and stainless steel discs.

WRP STREET

- CONTROLS
- BRAKE PADS
- CHAINS
- CANOPIES / TENTS

WRP OFF-ROAD

- CONTROLS
- BEARINGS & COMPONENTS
- BRAKE DISCS
- BRAKE PADS
- CHAINS
- SPROCKETS
- PROTECTIONS
- AIR & OIL FILTERS
- PLASTICS
- CANOPIES / TENTS



F6 - Standard
ORGANIC

Part No. Example WG-7275-F6

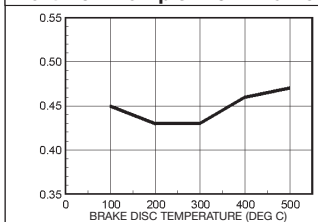

Good performance for easy handling at all temperature levels. Suitable for cast iron and stainless steel discs.



F2 - Supersport
SINTERED

Part No. Example WG-7291-F2

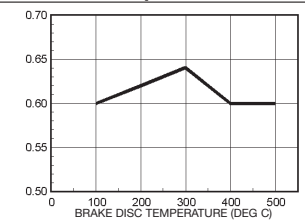

FRONT PADS - Especially developed for high performance street application. Suitable for OE cast iron and stainless steel discs.



F3 - Supersport
SINTERED

Part No. Example WG-7369-F3

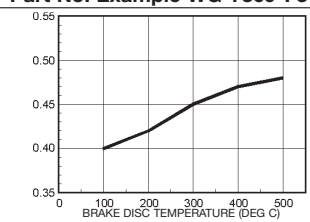

REAR PADS - Slightly reduced coefficient of friction to achieve maximum controlled stopping power. Suitable for OE cast iron and stainless steel discs.





OFF-ROAD CHAINS		
DESCRIPTION	N. LINKS	P/N
420 PMX		
PRE-CUT CHAIN	120	WE420PMX-120
PRE-CUT CHAIN	130	WE420PMX-130
RIVET CONNECTING LINK	1	WE420PMX-RCL
SPRING CONNECTING LINK	1	WE420PMX-SCL
428 PMX		
PRE-CUT CHAIN	120	WE428PMX-120
PRE-CUT CHAIN	130	WE428PMX-130
RIVET CONNECTING LINK	1	WE428PMX-RCL
SPRING CONNECTING LINK	1	WE428PMX-SCL
520 PMX		
PRE-CUT CHAIN	114	WE520PMX-114
PRE-CUT CHAIN	120	WE520PMX-120
ROLL (10 MT)	630	WE520PMX-R10
RIVET CONNECTING LINK	1	WE520PMX-RCL
SPRING CONNECTING LINK	1	WE520PMX-SCL
520 LZR		
PRE-CUT Z-RING CHAIN	114	WE520LZR-114
PRE-CUT Z-RING CHAIN	120	WE520LZR-120
RIVET CONNECTING LINK	1	WE520LZR-RCL
SPRING CONNECTING LINK	1	WE520LZR-SCL



WRP STREET	CONTROLS
	BRAKE PADS
	CHAINS
	CANOPIES / TENTS

OFF-ROAD CHAINS

- HIGH PERFORMANCE LIGHTWEIGHT CHAIN WITH SUPERIOR STRENGTH AND EXCELLENT WEAR RESISTANCE
- MANUFACTURED FROM SPECIAL HEAT-TREATED STEEL
- GOLD OUTER FINISH AND CHROMED BEARING PINS TO RESIST CORROSION AND TO EXTEND CHAIN LIFE

“LZR” / Z-RING CHAINS

- LIGHTWEIGHT CHAIN DESIGNED FOR OFF-ROAD RACING AND ATV
- LOW FRICTION Z-RINGS OIL SEAL FOR MAXIMUM PERFORMANCE AND DURABILITY

“PMX” / NON O-RING CHAINS

- DESIGNED EXCLUSIVELY FOR MOTOCROSS RACING USE
- AVAILABLE ALSO IN 420 AND 428 SIZES PROVIDING CLASS LEADING PERFORMANCE FOR MINICROSS BIKES

WRP OFF-ROAD	CONTROLS
	BEARINGS & COMPONENTS
	BRAKE DISCS
	BRAKE PADS
	CHAINS
	SPROCKETS
	PROTECTIONS
	AIR & OIL FILTERS
PLASTICS	
CANOPIES / TENTS	



WRP CHAIN	TENSILE STRENGTH		SEAL RING	MOTOCROSS				ENDURO / ATV					TRIAL				
	N	Lbs		50	125	250	500	50	85	125	250	500	750	900	50	125	350
420 PMX	21.000	4.721	-	●				●	●						●		
428 PMX	20.500	4.609	-	●					●							●	
520 PMX	34.000	7.644	-		●	●	●			●	●	●				●	●
520 LZR	35.000	7.868	Z		●	●	●			●	●	●				●	●

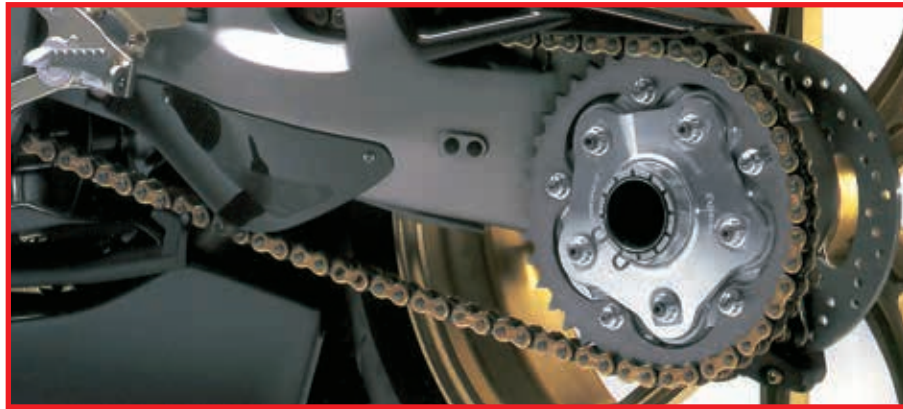

MADE IN EUROPE



X-RING CHAINS

- HIGH PERFORMANCE LIGHTWEIGHT CHAIN WITH SUPERIOR STRENGTH AND EXCELLENT WEAR RESISTANCE
- MANUFACTURED FROM SPECIAL HEAT-TREATED STEEL
- GOLD OUTER FINISH AND CHROMED BEARING PINS TO RESIST CORROSION AND TO EXTEND CHAIN LIFE
- ULTRA LOW FRICTION X-RINGS OIL SEAL FOR MAXIMUM PERFORMANCE AND DURABILITY

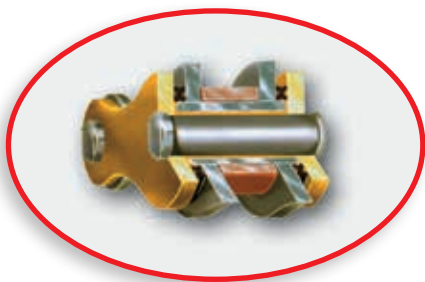

SPORTBIKE & STREET CHAINS

DESCRIPTION	N. LINKS	P/N
520 HXR		
PRE-CUT X-RING CHAIN	106	WEC520HXR-106
PRE-CUT X-RING CHAIN	116	WEC520HXR-116
PRE-CUT X-RING CHAIN	120	WEC520HXR-120
RIVET CONNECTING LINK	1	WEC520HXR-RCL
525 HXR		
PRE-CUT X-RING CHAIN	110	WEC525HXR-110
PRE-CUT X-RING CHAIN	120	WEC525HXR-120
PRE-CUT X-RING CHAIN	124	WEC525HXR-124
RIVET CONNECTING LINK	1	WEC525HXR-RCL
530 HXR		
PRE-CUT X-RING CHAIN	108	WEC530HXR-108
PRE-CUT X-RING CHAIN	120	WEC530HXR-120
RIVET CONNECTING LINK	1	WEC530HXR-RCL

WRP CHAIN APPLICATION CHART

WRP CHAIN	TENSILE STRENGTH		SEAL RING	TOURING						SPORT				
	N	Lbs		125	250	350 500	550 600	650 750	900 1300	125	250 350	400 650	750 900	1000 1300
520 LOR	34.000	7.644	O	●	●	●				●	●			
520 HXR	36.500	8.206	X					●	●			●	●	●
525 HXR	40.600	9.127	X					●	●			●	●	●
530 HXR	43.400	9.757	X				●	●	●			●	●	●

WRP STREET

- CONTROLS
- BRAKE PADS
- CHAINS
- CANOPIES / TENTS

WRP OFF-ROAD

- CONTROLS
- BEARINGS & COMPONENTS
- BRAKE DISCS
- BRAKE PADS
- CHAINS
- SPROCKETS
- PROTECTIONS
- AIR & OIL FILTERS
- PLASTICS
- CANOPIES / TENTS



FRONT SPROCKETS

- MANUFACTURED FROM CHROMOLY STEEL
- SELF-CLEANING MUD GROOVES TO INCREASE CHAIN AND SPROCKET LIFE
- O.E.M. AND OPTIONAL GEARING AVAILABLE FOR THE MOST POPULAR OFF-ROAD RACING BIKES

REAR SPROCKETS

- CNC MACHINED FROM SPECIAL BILLET ALUMINUM ALLOY FOR MAXIMUM RESISTANCE
- ANODIZED FINISH TO AVOID CORROSION
- SELF-CLEANING MUD GROOVES TO INCREASE CHAIN AND SPROCKET LIFE
- MACHINED LIGHTENING FOR MAXIMUM WEIGHT REDUCTION WITHOUT COMPROMISING STRENGTH
- O.E.M. AND OPTIONAL GEARING AVAILABLE FOR THE MOST POPULAR OFF-ROAD RACING BIKES



MADE IN EUROPE



MAKE / MODEL	CC	YEAR	FRONT SPROCKETS				REAR SPROCKETS					CHAIN	
			TEETH NUMBER			P/N	TEETH NUMBER				P/N		
			OEM	-1	+1		OEM	-2	-1	+1			+2
SUZUKI													
RM	125	04-05	12		13	WFP9332 - ..	50	48	49	51		WFC9112 - ..	520
RM	125	06-09	12		13	WFP9332 - ..	51	49	50			WFC9112 - ..	520
DR-Z	250	04-07	13	12	14	WFP9333 - ..	49	47	48	50	51	WFC9112 - ..	520
LT - ATV	250	03	12	11	13	WFP9333 - ..							520
RM	250	89-97	13	12	14	WFP9333 - ..	49	47	48	50	51	WFC9112 - ..	520
RM	250	98	13	12	14	WFP9333 - ..	50	48	49	51		WFC9112 - ..	520
RM	250	99	13	12	14	WFP9333 - ..	49	47	48	50	51	WFC9112 - ..	520
RM	250	00	13	12	14	WFP9333 - ..	48		47	49	50	WFC9112 - ..	520
RM	250	01-03	13	12	14	WFP9333 - ..	49	47	48	50	51	WFC9112 - ..	520
RM	250	04-09	13	12	14	WFP9333 - ..	50	48	49	51		WFC9112 - ..	520
RM-X	250	90-98	13	12	14	WFP9333 - ..	50	48	49	51		WFC9112 - ..	520
RM-Z	250	04-06	13	12	14	WFP9438 - ..	48	46	47	49	50	WFC9107 - ..	520
RM-Z	250	07-09	12		13	WFP9332 - ..	48		47	49	50	WFC9112 - ..	520
RM-Z	250	10-12	13	12		WFP9332 - ..	49	47	48	50	51	WFC9112 - ..	520
RM-Z	250	13-17	13			WFP9349 - ..	49	47	48	50	51	WFC9112 - ..	520
DR-Z E / S	400	00-09	13	14		WFP9333 - ..	47			48	49	WFC9112 - ..	520
LT-Z - ATV	400	03-09	14	13	15	WFP9334 - ..							520
LT-R - ATV	450	06-10	14	13	15	WFP9334 - ..							520
RM-Z	450	05	14	13	15	WFP74075 - ..	49	47	48	50	51	WFC9112 - ..	520
RM-Z	450	06-07	14	13	15	WFP74075 - ..	48		47	49	50	WFC9112 - ..	520
RM-Z	450	08-17	13		14	WFP74075 - ..	50	48	49	51		WFC9112 - ..	520
RMX-Z	450	10-17	13		14	WFP74075 - ..	51	49	50			WFC9112 - ..	520
YAMAHA													
YZ	80	85-92	14	13		WFP9108 - ..	46					WFC9148 - ..	428
YZ	80	93-01	14	13		WFP9108 - ..	47			48		WFC9141 - ..	428
YZ (B/W)	80	94-01	13		14	WFP9108 - ..	47			48		WFC9141 - ..	428
YZ	85	02-17	14			WFP9111 - ..	47			48		WFC9141 - ..	428
YZ (B/W)	85	02-15	14			WFP9111 - ..	52		51	53		WFC9141 - ..	428
YZ	125	89-96	13		14	WFP9336 - ..	50	48	49	51	52	WFC9103 - ..	520
YZ	125	97-98	13		14	WFP9336 - ..	48			49	50	WFC9103 - ..	520
YZ	125	99-01	13		14	WFP9336 - ..	48	46	47	49	50	WFC9339 - ..	520
YZ	125	02-04	13		14	WFP9336 - ..	49	47	48	50	51	WFC9339 - ..	520
YZ	125	05-17	13	12	14	WFP9503 - ..	48	46	47	49	50	WFC9339 - ..	520
WR	200	91-92					52	50	51			WFC9103 - ..	520
WR	200	93-94	13		14	WFP9336 - ..	52	50	51			WFC9103 - ..	520
WR	250	91-96					52	50	51			WFC9103 - ..	520
WR	250	97-00	14	13	15	WFP9439 - ..	48	46	47	49	50	WFC9339 - ..	520
YZ	250	90-93					51	49	50	52		WFC9103 - ..	520
YZ	250	94-98					49		48	50	51	WFC9103 - ..	520
YZ	250	99-01	14	13	15	WFP9439 - ..	50	48	49	51	52	WFC9339 - ..	520
YZ	250	02-04	14	13	15	WFP9439 - ..	49	47	48	50	51	WFC9339 - ..	520
YZ	250	05-17	14	13	15	WFP9439 - ..	50	48	49	51	52	WFC9339 - ..	520
YZF	250	01-04	13	12	14	WFP9503 - ..	48	46	47	49	50	WFC9339 - ..	520
YZF	250	05-09	13	12	14	WFP9503 - ..	49	47	48	50	51	WFC9339 - ..	520
YZF	250	10-17	13	12	14	WFP9503 - ..	50	48	49	51	52	WFC9339 - ..	520
WRF	250	01-07	13	12	14	WFP9503 - ..	52	50	51	53		WFC9339 - ..	520
WRF	250	08-17	13	12	14	WFP9503 - ..	50	48	49	51	52	WFC9339 - ..	520
YZF / WRF	400	98	14	13	15	WFP9439 - ..	49		48	50	51	WFC9103 - ..	520
WRF	400	99-00	14	13	15	WFP9439 - ..	50	48	49	51	52	WFC9339 - ..	520
YZF	400	99	14	13	15	WFP9439 - ..	49	47	48	50	51	WFC9339 - ..	520
YZF	426	00	14	13	15	WFP9439 - ..	50	48	49	51	52	WFC9339 - ..	520
YZF	426	01-02	13		14	WFP9439 - ..	49	47	48	50	51	WFC9339 - ..	520
YZF	450	03-04	14	13	15	WFP9439 - ..	48	46	47	49	50	WFC9339 - ..	520
YZF	450	05	14	13	15	WFP9439 - ..	51	49	50	52	53	WFC9339 - ..	520
YZF	450	06-09	13		15	WFP9439 - ..	49	47	48	50	51	WFC9339 - ..	520
YZF	450	10-13	13		15	WFP9439 - ..	48	46	47	49	50	WFC9339 - ..	520
YZF	450	2014	13		15	WFP9439 - ..	49	47	48	50	51	WFC9339 - ..	520
YZF	450	15-17	13		15	WFP9439 - ..	48	46	47	49	50	WFC9339 - ..	520
WRF	450	03-04	14	13	15	WFP9439 - ..	47		46	48	49	WFC9339 - ..	520
WRF	450	05-09	14	13	15	WFP9439 - ..	50	48	49	51	52	WFC9339 - ..	520
WRF	450	10-17	13	14		WFP9439 - ..	50	48	49	51	52	WFC9339 - ..	520

WRP STREET

- CONTROLS
- BRAKE PADS
- CHAINS
- CANOPIES / TENTS

WRP OFF-ROAD

- CONTROLS
- BEARINGS & COMPONENTS
- BRAKE DISCS
- BRAKE PADS
- CHAINS
- SPROCKETS
- PROTECTIONS
- AIR & OIL FILTERS
- PLASTICS
- CANOPIES / TENTS





ENDURO GLIDE PLATE

MAKE / MODEL	CC	YEAR	P/N
APRILIA			
RXV	450/550	09-11	WX-16134
BETA			
RE / RR	125	08-14	WX-16149
RR	125	15	WX-16157
RR LC	125	10-15	WX-16327
RR	250/400/450/525	05-09	WX-16080
RR 2-stroke	250/300	13-15	WX-16316
ALP 4.0	350	10-14	WX-16636
RR	350 > 520	10-15	WX-16136
BMW			
GX	450	08-11	WX-16096
GAS GAS			
EC / MC	125	00-09	WX-16000
EC	125	10-11	WX-16110
EC	125	12-13	WX-16323
EC / MC	200/250/300	00-09	WX-16001
EC	200/250/300	10	WX-16112
EC	200/250/300	11	WX-16133
EC	200/250/300	12-13	WX-16988
EC	250/300	14-15	WX-16429
EC-F 4-stroke	250	10-11	WX-16114
EC-F 4-stroke	250	12-13	WX-16996
EC-F 4-stroke	450	09	WX-16105
EC-F 4-stroke	450	12-13	WX-16117
HONDA			
CRF	150	07-16	WX-16313
CRF	230	07-09	WX-16064
CRF / CRF E	250	04-09	WX-16006
CRF / CRF E	250	10	WX-16098
CRF / CRF E	250	11-13	WX-16140
CRF / CRF E	250	14-17	WX-16326
CRF L/M	250	13-14	WX-16435
CRF-X	250	04-14	WX-16082
CRF / CRF E	450	02-04	WX-16008
CRF / CRF E	450	05-08	WX-16010
CRF / CRF E	450	09-12	WX-16091
CRF / CRF E	450	13-15	WX-16314
CRF / CRF E	450	2016	WX-16162
CRF-X	450	05-14	WX-16009
HUSABERG			
TE	125	12-14	WX-16095
FE	250	13	WX-16309
FE	250	14	WX-16511
TE	250/300	11-12	WX-16127
TE	250/300	13-14	WX-16097
TC	250	14	WX-16097
FE	350	13	WX-16984
FE	350	14	WX-16511
FE	450/550/650	06-08	WX-16072
FE	450/570	08-12	WX-16093
FE	450/501	13	WX-16985
HUSQVARNA			
TC	85	2016	WX-16554
CR / WR 2-stroke	125	08-12	WX-16119
TE	125	14	WX-16632
CR / WR 2-stroke	250/300	08-13	WX-16090
FE / FC	250/350	14-15	WX-16511
FE	250/350	2016	WX-16511
TE / TC	250/450/510	04-07	WX-16015
TE / TC	230/310/450/510	08-10	WX-16054
TE / TC	250	08-09	WX-16054
TE / TC	250	10	WX-16108
TE / TC	250/310	11-13	WX-16139
TE	250/300	14-15	WX-16097
TE	250/300	2016	WX-16156
TE / TC	449/511	11-13	WX-16138
TE	610	06-08	WX-16086

MAKE / MODEL	CC	YEAR	P/N
KAWASAKI			
KX	85	04-13	WX-16312
KX-F	250	06-08	WX-16061
KX-F	250	09	WX-16094
KX-F	250	10-16	WX-16122
KX-F	250	2017	WX-16173
KX-F	450	06-08	WX-16087
KX-F	450	09-15	WX-16088
KX-F	450	16-17	WX-16552
KTM			
SX	85	04-12	WX-16304
SX	85	13-15	WX-16320
SX	85	2016	WX-16554
EXC	125/200	04-07	WX-16073
EXC	125/200	08-16	WX-16095
SX	125/200	04-06	WX-16073
SX	125/150/200	07-11	WX-16095
SX / XC	125/150	12-15	WX-16107
SX	125/150	2016	WX-16164
EXC	250/300	01-07	WX-16129
EXC	250/300	08-10	WX-16070
EXC	250/300	11	WX-16127
EXC	250/300	12-16	WX-16097
EXC	250/300	2017	WX-16167
SX	250	01-06	WX-16129
SX	250	07-10	WX-16070
SX	250	11	WX-16127
SX / XC	250/300	12-14	WX-16100
EXC-F	250	07	WX-16031
EXC-F	250	08-11	WX-16033
EXC-F	250	12-13	WX-16309
EXC-F	250	14-16	WX-16522
EXC-F	250/400/450/525	01-03	WX-16036
FREERIDE	250	14-15	WX-16546
SX-F	250	06	WX-16031
SX-F	250	07-09	WX-16033
SX-F	250	10	WX-16121
SX-F	250	11	WX-16132
SX-F	250	12	WX-16190
SX-F	250	13-14	WX-16319
SX-F	250	2015	WX-16511
SX-F / XC-F	250/350	2016	WX-16551
EXC-F	350	12-14	WX-16984
EXC-F	350	15-16	WX-16522
SX-F	350	11-15	WX-16128
XC-F	350	12-14	WX-16311
EXC-F	400/450/525	04-07	WX-16032
EXC-F	400/450/530	08-11	WX-16034
EXC-F	450/500	12-16	WX-16985
EXC-F	450/500	2017	WX-16168
SX-F	400/450	00-02	WX-16036
SX-F	400/450/525	03-06	WX-16032
SX-F	450/505	07-10	WX-16030
SX-F	450	11-12	WX-16131
SX-F	450	13-14	WX-16985
SX-F / XC-F	450	2016	WX-16553
SHERCO			
SE 2-stroke	250/300	13-15	WX-16399
SEF	250/300	12-14	WX-16392
SUZUKI			
RM	85	02-15	WX-16306
RM-Z	250	07-09	WX-16042
RM-Z	250	10-14	WX-16102
RM-Z	250	2015	WX-16538
RM-Z	250	2016	WX-16160
RM-Z	250	2017	WX-16172
DRZ	400	00-15	WX-16126
RM-Z	450	05-07	WX-16043
RM-Z	450	08-09	WX-16046



MAKE / MODEL	CC	YEAR	P/N
SUZUKI			
RM-Z	450	10-15	WX-16120
RM-Z	250	07-09	WX-16042
RM-Z	450	16-17	WX-16161
RMX-Z	450	10-12	WX-16115
TM			
EN / MX 2-stroke	125/144	08-15	WX-16083
EN / MX 2-stroke	125/144	2016	WX-16158
EN / MX 2-stroke	250/300	04-07	WX-16003
EN / MX 2-stroke	250/300	08-10	WX-16081
EN / MX 2-stroke	250/300	11-14	WX-16125
EN / MX 2-stroke	250/300	2015	WX-16547
EN 2-stroke	250/300	2016	WX-16155
EN-F 4-stroke	250	11-14	WX-16159
EN-F 4-stroke	250	2015	WX-16148
EN-F 4-stroke	450/530	08-14	WX-16085
MX-F 4-stroke	250/450/530	08-14	WX-16085
YAMAHA			
YZ	85	04-17	WX-16310
YZ	250	05-17	WX-16077
WRF	250	07-14	WX-16052
WRF	250	15-16	WX-16545
YZF	250	06-09	WX-16074
YZF	250	10-13	WX-16104
YZF	250	14-16	WX-16428
YZF	450	06-09	WX-16057
YZF	450	10-13	WX-16106
YZF	450	14-16	WX-16324
WRF	450	03-06	WX-16166
WRF	450	07-11	WX-16137
WRF	450	12-15	WX-16198
WRF	450	2016	WX-16163

ENDURO ENGINE PROTECTIONS

- HIGH QUALITY LIGHTWEIGHT ALUMINUM PLATE
- THE BEST WAY TO PROTECT YOUR ENGINE CASE FROM MAJOR DAMAGES
- HELPS TO SLIDE OVER SUPERCROSS-STYLE BUMPS



WRP STREET

- CONTROLS
- BRAKE PADS
- CHAINS
- CANOPIES / TENTS

WRP OFF-ROAD

- CONTROLS
- BEARINGS & COMPONENTS
- BRAKE DISCS
- BRAKE PADS
- CHAINS
- SPROCKETS
- PROTECTIONS
- AIR & OIL FILTERS
- PLASTICS
- CANOPIES / TENTS

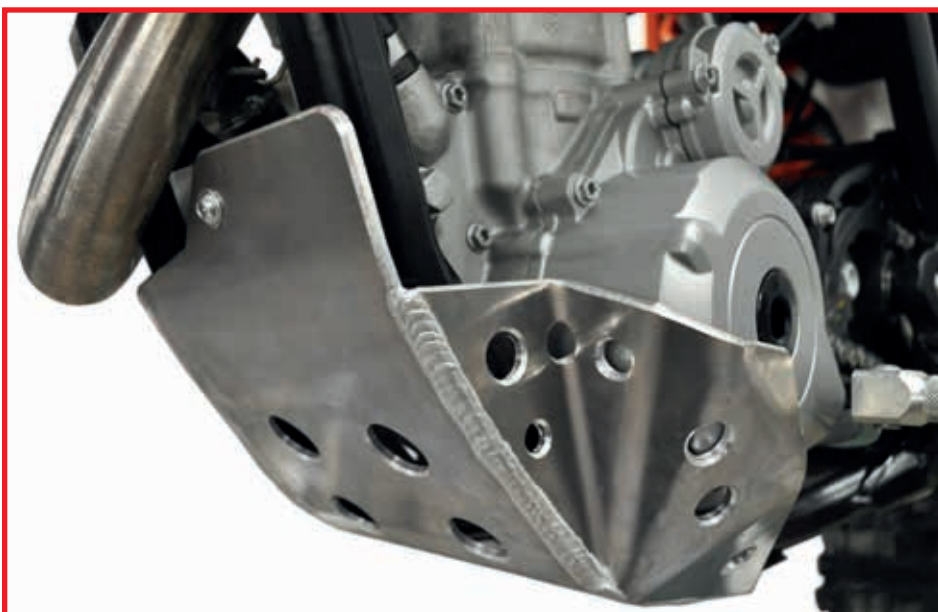

MADE IN EUROPE



MX SKID PLATE

MAKE / MODEL	CC	YEAR	P/N
APRILIA			
RXV	450/550	09-11	WX-15134
BETA			
RR LC	125	10-15	WX-15327
RR 2-stroke	250/300	13-15	WX-15316
RR 4-stroke	250/400/450/525	05-09	WX-15070
RR	350>520	11-15	WX-15136
BMW			
GX	450	08-11	WX-15096
GAS GAS			
EC / MC	125	00-09	WX-15109
EC / MC	125	10-11	WX-15110
EC	125	12-13	WX-15323
EC / MC	200/250/300	00-09	WX-15001
EC / MC 2-stroke	200/250/300	10	WX-15112
EC 2-stroke	200/250/300	11	WX-15133
EC 2-stroke	200/250/300	12-13	WX-15988
EC 2-stroke	250/300	14-15	WX-15429
EC-F 4-stroke	250	10-11	WX-15114
HONDA			
CRF	150	07-16	WX-15313
CRF	230	07-09	WX-15064
CRF	250	04-09	WX-15007
CRF	250	10-13	WX-15098
CRF	250	14-17	WX-15326
CRF-X	250	04-14	WX-15082
CRF	450	02-04	WX-15008
CRF	450	05-08	WX-15009
CRF	450	09-12	WX-15091
CRF	450	13-15	WX-15314
CRF	450	2016	WX-15162
CRF-X	450	05-14	WX-15010
HUSABERG			
TE	125	12-14	WX-15095
FE	250	13	WX-15309
FE	250	14	WX-15322
TE	250/300	11-12	WX-15125
TE	250/300	13-14	WX-15097
TC	250	14	WX-15100
FE	350	13-14	WX-15184
FE	450/550/650	06-08	WX-15072
FE	450/570	09-12	WX-15093
FE	450/501	13	WX-15185
HUSQVARNA			
TC	85	2016	WX-15554
CR / WR 2-stroke	125	08-12	WX-15119
CR / WR 2-stroke	250/300	08-13	WX-15090
FC / FE	250/350/450	14-15	WX-15511
FC	250/350	2016	WX-15551
FE	250/350	2016	WX-15511
FC	450	2016	WX-15553
TE / TC	250/450/510	04-07	WX-15015
TE / TC	250	08-09	WX-15059
TE / TC	250	10	WX-15108
TE / TC	250/310	08-13	WX-15139
TE	250/300	14-15	WX-15533
TE	250/300	2016	WX-15156
TE / TC	310/450/510	08-10	WX-15059
TE / TC	449/511	11-13	WX-15138
TE	610	06-09	WX-15636
KAWASAKI			
KX	85	04-13	WX-15312
KX-F	250	06-08	WX-15021
KX-F	250	09	WX-15094

MAKE / MODEL	CC	YEAR	P/N
KAWASAKI			
KX-F	250	10-16	WX-15122
KX-F	250	2017	WX-15173
KLX-R	450	08-15	WX-15058
KX-F	450	06-08	WX-15087
KX-F	450	09-15	WX-15088
KX-F	450	16-17	WX-15552
KTM			
SX	85	04-12	WX-15304
SX	85	13-15	WX-15320
SX	85	2016	WX-15554
EXC	125/200	04-07	WX-15140
EXC	125/200	08-16	WX-15095
SX	125/200	04-06	WX-15140
SX	125/150/200	07-11	WX-15095
SX / XC	125/150	12-15	WX-15607
SX	125/150	2016	WX-15164
EXC	250/300	01-07	WX-15079
EXC	250/300	08-10	WX-15027
EXC	250/300	11	WX-15125
EXC	250/300	12-16	WX-15097
EXC	250/300	2017	WX-15167
SX	250	01-06	WX-15079
SX	250	07-10	WX-15027
SX	250	11	WX-15125
SX / XC	250/300	12-14	WX-15100
EXC-F	250/400/450/525	01-03	WX-15036
EXC-F	250	07	WX-15627
EXC-F	250	08-11	WX-15037
EXC-F	250	12-13	WX-15309
EXC-F	250	14-16	WX-15322
SX-F	250	06	WX-15627
SX-F	250	07-09	WX-15037
SX-F	250	10	WX-15121
SX-F	250	11	WX-15132
SX-F	250	12	WX-15190
SX-F	250	13-14	WX-15319
SX-F	250	2015	WX-15511
SX-F / XC-F	250/350	2016	WX-15551
EXC-F	350	12-14	WX-15184
EXC-F	350	15-16	WX-15322
SX-F	350	11-14	WX-15126
XC-F	350	12-14	WX-15311
EXC-F	400/450/525	04-07	WX-15034
EXC-F	400/450	08-11	WX-15035
EXC-F	450/500	12-16	WX-15185
EXC-F	450/500	2017	WX-15168
SX-F	400/450	00-02	WX-15036
SX-F	400/450/525	03-06	WX-15034
SX-F	450	07-10	WX-15030
SX-F	450	11-12	WX-15127
SX-F	450	13-14	WX-15185
SX-F / XC-F	450	2016	WX-15553
EXC-R	530	08-11	WX-15035
SHERCO			
SE 2-stroke	250/300	14-15	WX-15399
SEF	250/300	12-14	WX-15392
SUZUKI			
RM	85	02-15	WX-15306
RM-Z	250	07-09	WX-15042
RM-Z	250	10-14	WX-15102
RM-Z	250	2015	WX-15538
RM-Z	250	2016	WX-15160
RM-Z	250	2017	WX-15172
DRZ	400	00-15	WX-15068



MAKE / MODEL	CC	YEAR	P/N
SUZUKI			
RM-Z	450	05-07	WX-15041
RM-Z	450	08-09	WX-15046
RM-Z	450	10-15	WX-15120
RM-Z	450	16-17	WX-15161
RMX-Z	450	10-12	WX-15115
TM			
EN / MX 2-stroke	125/144	08-15	WX-15083
EN / MX 2-stroke	125/144	2016	WX-15158
EN / MX 2-stroke	250/300	04-07	WX-15003
EN / MX 2-stroke	250/300	08-10	WX-15080
EN / MX 2-stroke	250/300	11-14	WX-15625
EN / MX 2-stroke	250/300	2015	WX-15547
EN 4-stroke	250	08-10	WX-15085
EN 4-stroke	250	10-14	WX-15159
EN 4-stroke	250	2015	WX-15148
MX 4-stroke	250	08-14	WX-15085
EN / MX 4-stroke	450/530	08-14	WX-15085
YAMAHA			
YZ	250	05-17	WX-15077
WRF	250	07-14	WX-15075
WRF	250	15-16	WX-15145
YZF	250	06-09	WX-15065
YZF	250	10-13	WX-15104
YZF	250	14-16	WX-15428
YZF	450	06-09	WX-15057
YZF	450	10-13	WX-15106
YZF	450	14-16	WX-15324
WRF	450	03-06	WX-15123
WRF	450	07-11	WX-15076
WRF	450	12-15	WX-15198
WRF	450	2016	WX-15163



WRP STREET	CONTROLS
	BRAKE PADS
	CHAINS
	CANOPIES / TENTS

WRP OFF-ROAD	CONTROLS
	BEARINGS & COMPONENTS
	BRAKE DISCS
	BRAKE PADS
	CHAINS
	SPROCKETS
	PROTECTIONS
	AIR & OIL FILTERS
	PLASTICS
CANOPIES / TENTS	

MX-ENDURO SKID PLATES

- HIGH QUALITY LIGHTWEIGHT ALUMINUM PLATE
- THE BEST WAY TO PROTECT YOUR ENGINE CASE FROM MAJOR DAMAGES
- HELPS TO SLIDE OVER SUPERCROSS-STYLE BUMPS



MADE IN EUROPE



RADIATOR GUARDS

MAKE / MODEL	CC	YEAR	P/N
APRILIA			
RXV	450/550	09-11	WX-14125
BETA			
RR 2-stroke	250/300	13-15	WX-14316
RR 4-stroke	250/400/450/498/520/525	05-15	WX-14070
BMW			
GX	450	08-11	WX-14096
GAS GAS			
EC / MC 2-stroke	125/200/250/300	00-15	WX-14423
EC 4-stroke	250/300/450	10-15	WX-14423
HONDA			
CRF	150	07-16	WX-14313
CRF	250	06-09	WX-14009
CRF	250	10-13	WX-14098
CRF	250	2014	WX-14326
CRF	250	15-17	WX-14543
CRF L/M	250	13-14	WX-14435
CRF-X	250	04-13	WX-14008
CRF / CRF E	450	05-08	WX-14011
CRF / CRF E	450	09-12	WX-14091
CRF / CRF E	450	13-14	WX-14314
CRF / CRF E	450	15-16	WX-14542
CRF-X	450	05-07	WX-14013
CRF-X	450	08-14	WX-14014
HUSABERG			
TE	125/250/300	12-14	WX-14141
TC	250	14	WX-14141
FE	250/350/450/501	13-14	WX-14140
FE	450/570	09-12	WX-14097
HUSQVARNA			
TC	85	2016	WX-14120
CR / WR 2-stroke	125/250/300	08-09	WX-14090
CR / WR 2-stroke	125/250/300	10-13	WX-14108
TE / TC / FC	125/250/300/350/450	2014	WX-14141
TE / TC / FC	125/250/300/350/450	2015	WX-14140
FC	250/350/450	2016	WX-14551
TE	250/300	2016	WX-14141
FE	250/350/450/501	14-16	WX-14140
TE / TC	250/450/510	04-07	WX-14015
TE / TC	250/310/450/510	08-09	WX-14055
TE / TC	250	10-13	WX-14108
TE	310	11-13	WX-14128
TE / TC	449/511	11-13	WX-14127
TE	610	06-08	WX-14086
KAWASAKI			
KX	85	04-14	WX-14312
KX-F	250	06-08	WX-14024
KX-F	250	09	WX-14094
KX-F	250	10-16	WX-14122
KX-F	250	2017	WX-14173
KLX-R	450	08-15	WX-14072
KX-F	450	06-08	WX-14072
KX-F	450	09	WX-14088
KX-F	450	10-11	WX-14188
KX-F	450	12-15	WX-14189
KX-F	450	16-17	WX-14552
KTM			
SX	85	04-12	WX-14304
SX	85	13-16	WX-14320
EXC / EXC-F	125/200/250/300	03-07	WX-14028
SX / SX-F	125/200/250	03-06	WX-14028
EXC	125/200/250/300/500/530	08-11	WX-14097
EXC	125/200/250/300	12-16	WX-14141
EXC	250/300	2017	WX-14167

MAKE / MODEL	CC	YEAR	P/N
KTM			
SX	125/150/250	07-10	WX-14097
SX / XC	125/150/250	11-14	WX-14141
SX / XC	125/150/250	2015	WX-14140
SX	125/150	2016	WX-14551
EXC-F	400/450/525	05-07	WX-14033
EXC-F	250/350/450	08-11	WX-14097
EXC-F	250/350/450/500	12-16	WX-14140
EXC-F	450/500	2017	WX-14168
FREERIDE	250	14-15	WX-14546
SX-F	450/525	05-06	WX-14033
SX-F	250/450	07-10	WX-14097
SX-F / XC-F	250/350/450	11-14	WX-14141
SX-F / XC-F	250/350/450	2015	WX-14140
SX-F / XC-F	250/350/450	2016	WX-14551
SHERCO			
SE	250/300	14-15	WX-14099
SEF 4-stroke	250/300	12-14	WX-14392
SEF 4-stroke	250/300	2015	WX-14134
SUZUKI			
RM	85	02-15	WX-14306
RM-Z	250	07-09	WX-14045
RM-Z	250	10-17	WX-14102
DRZ	400	00-15	WX-14124
RM-Z	450	05-07	WX-14044
RM-Z	450	08-09	WX-14046
RM-Z / RMX-Z	450	10-17	WX-14116
TM			
EN / MX 2-stroke	125/250/300	04-07	WX-14079
EN / MX 2-stroke	125/144/250/300	08-14	WX-14080
EN / MX 2-stroke	125/144/250/300	2015	WX-14547
EN 2-stroke	125/144	2016	WX-14158
EN 2-stroke	250/300	2016	WX-14155
EN / MX 4-stroke	250/450/530	09-14	WX-14085
YAMAHA			
YZ	85	04-16	WX-14310
YZ	125/250	05-17	WX-14077
YZF	250	06-09	WX-14074
YZF	250	10-13	WX-14104
YZF	250	14-16	WX-14324
WRF	250	07-14	WX-14058
WRF	250	15-16	WX-14545
YZF	450	06-09	WX-14065
YZF	450	10-13	WX-14106
YZF	450	14-16	WX-14324
WRF	450	03-06	WX-14123
WRF	450	07-11	WX-14058
WRF	450	12-15	WX-14198
WRF	450	2016	WX-14163

RADIATORS GUARDS

- HIGH QUALITY LIGHTWEIGHT ALUMINUM ARMOR
- DESIGNED TO PROTECT THE RADIATORS FROM CRASHES OR MAJOR DAMAGES
- EASY TO INSTALL



MADE IN EUROPE



DUAL-SPORT BIKE PROTECTIONS				
MAKE / MODEL	CC	YEAR	ALUMINUM ENGINE GUARD	SIDE CRASH BARS
BMW				
GS	650	08-12	WX-09005	WX-11005
GS	800	08-16	WX-09001	WX-11001
GS	1200	03-07	WX-09003	WX-11003
GS	1200	08-12	WX-09010	WX-11010
GS	1200	13-16	WX-09015	WX-11015
HONDA				
NC X	700	12-13	WX-09011	WX-11011
NC X	750	14-15	WX-09011	WX-11011
AFRICA TWIN	1000	16-17	WX-09023	WX-11023
AFRICA TWIN DUAL CLUTCH	1000	16-17	WX-09023	WX-11024
VARADERO	1000	07-11	WX-09004	WX-11004
VFR-X CROSSTOURER	1200	12-15	WX-09009	WX-11009
KTM				
DUKE	125/200	11-14	WX-09018	WX-12018
DUKE	390	13-14	WX-09021	WX-12021
LC8 ADVENTURE	950/990	07-12	WX-09013	WX-11013
LC8 SMT	990	11-13	WX-09016	WX-11016
ADVENTURE	1190	13-15	WX-09022	WX-12022
KAWASAKI				
KLR	650	08-15	WX-09014	WX-11014
KLE VERSYS	650	07-13	WX-09008	WX-11008
SUZUKI				
V-STROM	650	08-11	WX-09002	WX-11002
V-STROM	650	12-14	WX-09012	WX-11012
V-STROM	1000	00-13	WX-09006	WX-11006
V-STROM	1000	2014	WX-09017	WX-11017
TRIUMPH				
TIGER / XC	800	11-16	WX-09020	WX-11020
YAMAHA				
XTZ TÉNÉRÉ	660	08-12	WX-09007	WX-11007
XTZ SUPER TÉNÉRÉ	1200	10-14	WX-09019	WX-11019

WRP STREET

- CONTROLS
- BRAKE PADS
- CHAINS
- CANOPIES / TENTS

WRP OFF-ROAD

- CONTROLS
- BEARINGS & COMPONENTS
- BRAKE DISCS
- BRAKE PADS
- CHAINS
- SPROCKETS
- PROTECTIONS
- AIR & OIL FILTERS
- PLASTICS
- CANOPIES / TENTS





OFF-ROAD AIR FILTERS

MAKE / MODEL	YEAR	P/N
BETA		
ENDURO 250/400/450/525	05-12	WO-158028
ENDURO 2-stroke 250/300	13-17	WO-158033
ENDURO 4-stroke 350/400/450/525	13-17	WO-158033
HONDA		
CR 80 / 85	96-11	WO-150004
CR 125 / 250 / 500	89-99	WO-150204
CR 125 / 250	00-01	WO-150206
CR 125 / 250	02-07	WO-150207
CRF 125 F	2014	WO-150010
CRF 150 R	07-16	WO-150215
CRF / CRF-X 250	04-09	WO-150209
CRF 250	10-13	WO-150219
CRF 250	14-17	WO-150221
CRF-X 250	10-16	WO-150209
CRF 450	02	WO-150208
CRF 450	03-08	WO-150209
CRF 450	09-12	WO-150219
CRF 450	13-16	WO-150221
CRF 450 / CRF 450 RX	2017	WO-150224
CRF-X 450	05-16	WO-150209
XR-R 250 / 400 / 600 / 650L	85-14	WO-150601
HUSABERG		
TE 125 / 250 / 300 2-stroke	11-12	WO-154114
TE / FE 125 / 250 / 300 / 350 / 450 / 501	13	WO-154115
HUSQVARNA		
TC 65	2017	WO-154514
TC 85	14-17	WO-154115
TC / FC 125 / 250 / 350 / 450	14-15	WO-154115
TE / FE 125 / 250 / 300 / 350 / 450 / 501	13-16	WO-154115
TC 125 / FC 250/350/450	16-17	WO-154116
TX / TE / FE 125 / 150 / 250 / 300 / 350 / 450 / 501	2017	WO-154116
KAWASAKI		
KX 65	00-15	WO-151010
KX 80 / 85 / 100	91-16	WO-151009
KX 125 / 250	02-08	WO-151116
KX-F 250	04-05	WO-151117
KX-F 250	06-16	WO-151119
KX-F 250	2017	WO-151121
KX-F 450	06-15	WO-151119
KX-F 450	16-17	WO-151121
KTM		
50 Mini / Senior Adventure - SX Pro Jr LC	00-08	WO-154006
SX 60 / 65	00-17	WO-154514
SX 85	04	WO-154110
SX 85	05-12	WO-154112
SX 85	13-17	WO-154115
2 STROKE (ALL)	98-03	WO-154110
2 STROKE (ALL / 3 PINS)	04-06	WO-154112
4 STROKE (ALL)	00	WO-154110
4 STROKE (ALL)	01-07	WO-154112
EXC-F / R (ALL) / SMR 450 / 560	08-09	WO-154113
EXC / EXC-F / XC (ALL) / SMR 450 / 560	10-11	WO-154114
EXC / EXC-F / XC-W / XCF-W (ALL)	12-16	WO-154115
SX / SX-F / XC / XC-F (ALL)	11-15	WO-154115
SX 125/150 / SX-F/XC-F 250/350/450	16-17	WO-154116
SMR 450	12-15	WO-154115
SX-F (ALL)	07-09	WO-154113
SX / SX-F (ALL)	2010	WO-154114
LC4 Duke - LC4 Adventure 400 / 620 / 625 / 640	97-10	WO-154514
LC4 / Supermoto / Dukell 625 / 640 / 660	08-09	WO-154512
SUZUKI		
RM 65	03-10	WO-153010
RM 80 / 85	86-15	WO-153006
RM 125 / 250	96-01	WO-153211
RM 125 / 250	02	WO-153214
RM 125	03	WO-153214
RM 125	04-10	WO-153215
RM 250	03-10	WO-153215
RM-Z 250	04-06	WO-153217
RM-Z 250	07-17	WO-153215
RM-Z 450	05-17	WO-153215
RM-X 450	10-15	WO-153219

MAKE / MODEL	YEAR	P/N
YAMAHA		
YZ 85	02-15	WO-152012
YZ 125 / 250	97-17	WO-152213
YZF 250	97-13	WO-152213
YZF 250 / 450	14-17	WO-152218
YZF 450	03-09	WO-152213
YZF 450	10-13	WO-152216
WRF 250 / 450	98-02	WO-152213
WRF 250	03-14	WO-152215
WRF 250	15-17	WO-152218
WRF 450	03-15	WO-152215
WRF 450	16-17	WO-152218



1. COARSE OPEN-PORE CATCHES AIRBORNE DIRT, GRIME AND SAND
2. FINE OPEN-PORE INNER FOAM ACTS AS A SECOND FILTER TO TRAP THE SMALLEST PARTICLES STILL ENSURING MAXIMUM AIR PASSAGE
3. EXCLUSIVELY FORMULATED ADHESIVE WITHSTANDS REPEATED CLEANINGS, EVEN WITH HARSH SOLVENTS
4. FUSED OUTER AND INNER ELEMENTS PREVENT DIRT AND GRIME FROM BEING LODGED BETWEEN LAYERS
5. THICK, FLAT FOAM, GREASELESS SEALING RING ENSURES MAXIMUM CONTACT WITH YOUR AIRBOX, WHILE ACTING AS A BREATHABLE GASKET FOR INCREASED AIR PASSAGE



MADE IN HOLLAND by



- MADE AND RACE PROVEN BY THE WORLD LEADER IN FOAM AIR FILTERS
- FIREPROOF FOAM
- AVAILABLE AS A VALID OEM REPLACEMENT FOR THE MOST POPULAR OFF-ROAD BIKES AND ATV

ATV AIR FILTERS

MAKE / MODEL	YEAR	P/N
ARTIC CAT		
DVX 400	03-10	WO-153908
KING QUAD 400	10-17	WO-153908
HONDA		
TRX 450	06-12	WO-150928P
KAWASAKI		
KFX 400	03-06	WO-151801
KFX 450	07-14	WO-151802
PRAIRE BRUTE FORCE 650	03	WO-151913
KFX V-FORCE 700	04-10	WO-151913
PRAIRE 700	04-06	WO-151913
SUZUKI		
LTZ 250	04-11	WO-153511
LTZ 400 / EIGER 400 / KING QUAD 400 / VINS	03-14	WO-153908
LTR 450	06-11	WO-153910
TWIN PEAKS 700	04-05	WO-151913
YAMAHA		
WARRIOR / WOLVERINE / RAPTOR 350	87-14	WO-152903
YFZ 450	04-14	WO-152902
GRIZZLY 600 / 660	98-09	WO-152903
GRIZZLY 700	07-14	WO-152912
RAPTOR 660	01-05	WO-152904
RAPTOR 700	06-17	WO-152908



OFF-ROAD OIL FILTERS

MAKE / MODEL	CC	YEAR	P/N
APRILIA			
RXV / SXV	450 / 550	06-15	WO-3070
BETA			
RR ENDURO/SUPERMOTO	125	10-16	WO-3040
EVO 4T	250 / 300	09-16	WO-3020
BMW			
G450 X	450	09-12	WO-3071
GAS GAS			
EC-F	250	10-15	WO-3040
EC-F	450	13-15	WO-3040
FSE / SM	400	03-07	WO-3021
HONDA			
CRF-R	150	07-17	WO-3011
XR-R	200	81-03	WO-3021
CRF / CRF-X	250	04-17	WO-3011
XL-R / XR-RL	250	82-04	WO-3021
XR-R	350	83-87	WO-3021
XR-R	400	96-06	WO-3021
CRF	450	02-03	WO-3010
CRF / CRF-X	450	04-16	WO-3011
TRX-R / ER - ATV	450	04-13	WO-3011
XL-RL / XR-R	600	83-02	WO-3021
FMX	650	05-07	WO-3021
NX DOMINATOR	650	88-02	WO-3021
XR-RL	650	00-07	WO-3021
HUSABERG			
FE	250	13	WO-3052
FE	250	14	WO-3053
FE	350	13	WO-3053
FC	390	10-12	WO-3052
FC	450	04-06	WO-3050
FE / FS	450	04-08	WO-3050
FE	450	09-15	WO-3052
FE	501	13-15	WO-3052
FC	550	04-06	WO-3050
FE / FS	550	04-08	WO-3050
FE / FS	570	09-12	WO-3052
FE / FS	650	04-08	WO-3050
HUSQVARNA			
SMR/SMS4/TE 4T	125	11-13	WO-3040
TC / TE	250	10-13	WO-3011
FC / FE	250	14-16	WO-3053
TE	310	11-13	WO-3011
FC / FE	350	14-16	WO-3053
FC	450	14-16	WO-3053
FE	450	14-16	WO-3052
TC / TE / SM	310 / 450 / 510	08-10	WO-3070
FE	501	14-16	WO-3052
TC / TE / SMR	449 / 511	11-13	WO-3071
TE / SM / SMR	630	10-11	WO-3070
KAWASAKI			
KLX	110	02-15	WO-3021
KLX	125	10-15	WO-3021
KLX	250	06-17	WO-3021
KX-F	250	04-17	WO-3020
KLX	300	96-07	WO-3021
KFX - ATV	400	05-06	WO-3030
KLX	400	05-06	WO-3030
KFX-R - ATV	450	08-14	WO-3021
KLX-R	450	08-16	WO-3021
KX-F	450	06-15	WO-3021
KX-F	450	16-17	WO-3020
KTM			
EXC - 1st filter	250	03-06	WO-3050
EXC - 2nd filter	250	03-06	WO-3051
EXC-F / XC / XC-F	250	07-12	WO-3052
EXC-F / XC / XC-F	250	13-16	WO-3053
SX-F	250	05-12	WO-3052
SX-F	250	13-16	WO-3053
EXC-F	300	2015	WO-3053

MAKE / MODEL	CC	YEAR	P/N
KTM			
EXC-F	350	12-16	WO-3053
SX-F	350	11-16	WO-3053
EXC / SX - 1st filter	400	99-02	WO-3050
EXC / SX - 2nd filter	400	99-02	WO-3051
EXC - 1st filter	400	06-07	WO-3050
EXC - 2nd filter	400	06-07	WO-3051
EXC / SMR - 1st filter	450	03-07	WO-3050
EXC / SMR - 2nd filter	450	03-07	WO-3051
EXC / XC	450	12-16	WO-3052
SMR	450	13-14	WO-3052
EXC-R / SMR	450	08-12	WO-3053
SX - 1st filter	450	03-06	WO-3050
SX - 2nd filter	450	03-06	WO-3051
SX-F	450	07-12	WO-3053
SX-F	450	13-15	WO-3052
SX-F	450	2016	WO-3053
EXC / XC	500	12-16	WO-3052
EXC / SX-F	505	08-09	WO-3053
EXC / SX - 1st filter	520	99-02	WO-3050
EXC / SX - 2nd filter	520	99-02	WO-3051
EXC / SX - 1st filter	525	03-07	WO-3050
EXC / SX - 2nd filter	525	03-07	WO-3051
EXC-R	530	08-11	WO-3053
SMR - 1st filter	560	06-07	WO-3050
SMR - 2nd filter	560	06-07	WO-3051
Duke / EGS / EXE - 1st filter	620	ALL	WO-3050
LC4 - 1st filter	640	ALL	WO-3050
SMC - 1st filter	660	04-05	WO-3050
SMC - 2st filter	660	04-05	WO-3051
Duke / SMC - 1st filter	690	08-11	WO-3050
Duke / SMC - 2nd filter	690	08-11	WO-3051
Enduro / R - 1st filter	690	08-11	WO-3050
Enduro / R - 2nd filter	690	08-11	WO-3051
SHERCO			
SE / SX 2.5 / 3.0	250 / 300	08-15	WO-3071
SE / SM4.5 / 5.1	450 / 510	04-15	WO-3071
SUZUKI			
DR Z	110	03-07	WO-3021
RM-Z	250	04-17	WO-3020
DR Z S / E / SM	400	00-09	WO-3030
LT Z - ATV	400	03-09	WO-3030
LT R - ATV	450	06-09	WO-3030
RM-Z	450	05-17	WO-3020
RMX	450	10-15	WO-3030
TM			
EN / MX	250	08-15	WO-3040
EN / MX / SM	450	11-15	WO-3040
SM	530	07-15	WO-3040
YAMAHA			
WR-F	250	03-17	WO-3040
YFM - ATV	250	08-11	WO-3040
YZ-F	250	03-17	WO-3040
WR-F	450	03-17	WO-3040
YFZ - ATV	450	04-17	WO-3040
YZ-F	450	03-17	WO-3040

OIL FILTERS

- PAPER OIL FILTERS FOR THE MOST POPULAR OFF-ROAD BIKES AND ATV
- MEET OR EXCEED OEM STANDARDS



WRP STREET

- CONTROLS
- BRAKE PADS
- CHAINS
- CANOPIES / TENTS

WRP OFF-ROAD

- CONTROLS
- BEARINGS & COMPONENTS
- BRAKE DISCS
- BRAKE PADS
- CHAINS
- SPROCKETS
- PROTECTIONS
- AIR & OIL FILTERS
- PLASTICS
- CANOPIES / TENTS



UNIVERSAL PLASTICS			
DESCRIPTION	P/N	COLOURS	
RSX - MX-ENDURO HAND PROTECTORS - W/ mounting kit	WP92900		
RXC - MX-ENDURO HAND PROTECTORS - W/ mounting kit	WP92910		



RSX



- UNIVERSAL FITTING, EASY TO INSTALL
- HANDLEBAR DIRECT MOUNTING
- PLASTIC MOUNTING KIT INCLUDED



RXC



GAS GAS

MODEL	YEAR	P/N	COLOURS
FORK PROTECTORS (PAIR)			
MC / EC / FSR 125/200/250/300/450	06-08	WP93940	○ ●
MC / EC / FSR 125/200/250/300/450	09-13	WP99109	●
FRONT FENDER			
EC 125/200 / EC 300 / EC 250/450/450 FSE	05-07	WP95668	●
EC 125/200 / EC 300 / EC 250/450/450 FSE	08-10	WP95718	● ● ●
MC / EC 125/200/250/300/450	11	WP95953	○ ● ● ●
ECF 250-300	11-13	WP95953	○ ● ● ●
RADIATOR COVERS (PAIR)			
EC 125/200	05-06	WP94264	○ ● ● ●
EC 250/450	05-06	WP94265	● ● ● ●
EC 300	05-06	WP94266	● ● ● ●
EC 125/200/250/300 / EC 450 FSE	07-09	WP94326	● ● ● ●
MC / EC 125/200/250/300/450	10-11	WP94133	● ● ● ●
ECF 250-300	11-13	WP94133	● ● ● ●
SIDE PANELS (PAIR)			
MC / EC / FSR 125/200/250/300/450	05-06	WP96036	○
REAR FENDER W/ SIDE PANELS			
EC 125/200/250/300 / 450 FSE	07-09	WP95699	● ● ● ●
MC / EC 125/200/250/300/450	10-11	WP95508	○ ● ● ●
ECF 250-300	11-13	WP95508	○ ● ● ●
REAR FENDER			
EC 125/200/250/300/450	05-06	WP95669	●

WRP STREET
 CONTROLS
 BRAKE PADS
 CHAINS
 CANOPIES / TENTS

WRP OFF-ROAD
 CONTROLS
 BEARINGS & COMPONENTS
 BRAKE DISCS
 BRAKE PADS
 CHAINS
 SPROCKETS
 PROTECTIONS
 AIR & OIL FILTERS
 PLASTICS
 CANOPIES / TENTS



HUSABERG

MODEL	YEAR	P/N	COLOURS
FORK PROTECTORS (PAIR)			
FC/FE/TE ALL CC	11-14	WP99120	○ ●
FRONT FENDER			
FC/FE/TE ALL CC	03-12	WP95612	● ● ●
SIDE PANELS			
TE 2-STROKE 125/250/300 (LEFT SIDE AIRBOX PANEL)	11-12	WP99122	●
TE 2-STROKE 125/250/300 (RIGHT SIDE AIRBOX PANEL)	11-12	WP99123	●
REAR FENDER W/ SIDE PANELS			
TE 2-STROKE 125/250/300	11-12	WP99124	○ ●
SWINGARM PROTECTOR / CHAIN SLIDER			
ALL MODELS	97-08	WP94513	●
ALL MODELS	09-12	WP94526	●
REAR SPROCKET CHAIN GUIDE			
ALL MODELS	09-14	WP94900	●
REAR SHOCK PROTECTION			
TE 125/250/300	11-14	WP99128	●
FE 250/350/450/501	13-14	WP99128	●



OEM ALTERNATIVE PARTS, INJECTED HIGH QUALITY PLASTIC, SHINING ORIGINAL MATCHING COLOURS



HONDA



MODEL	YEAR	P/N	COLOURS
FORK PROTECTORS (PAIR)			
CR 85	03-07	WP93513	○
CRF 150R	07-17		○
CR 125 / 250 / 500	95-07	WP93940	○ ● ●
CRF 250 / CRF-X 250/450	02-17		○ ● ●
CRF 450	02-16		○ ● ●
CRF 450 / CRF-RX 450	2017		● ● ○
FRONT NUMBER PLATE			
CR 80 / 85	96-07	WP96622	○
CRF 150R	07-17	WP96632	○
CR 125 / 250 - CRF 250 / 450	04-07	WP96619	○ ● ●
CRF 250	08-09	WP96575	○ ● ●
CRF 450	08		○ ● ●
CRF 250	10-13	WP96567	○ ● ●
CRF 450	09-12		○ ● ●
CRF 250	14-17	WP99159	○ ● ●
CRF 450	13-16		○ ● ●
CRF 450 / CRF-RX 450	2017	WP99234	○ ● ●
FRONT FENDER			
CR 80 / 85	96-07	WP95633	●
CRF 150R	04-17	WP95692	●
CR 125 / 250	04-07		● ● ○
CRF 250	04-09	WP95626	● ● ○
CRF 450	04-08		● ● ○
CRF-X 250 / 450	04-17	WP95727	● ● ○
CRF 250	10-13		● ● ○
CRF 450	09-12	WP99155	● ● ○
CRF 250	14-17		● ● ○
CRF 450	13-16	WP99230	● ● ○
CRF 450 / CRF-RX 450	2017		● ● ○
XR 250 / 400	96-07	WP99100	●
RADIATOR COVERS (PAIR)			
CR 85	03-07	WP94106	●
CR 125 / 250	02-07	WP94270	● ●
CRF 150R	07-17	WP94122	●
CRF 250	04-09		● ● ○
CRF-X 250	04-17	WP94103	● ● ○
CRF 250	10-13		● ● ○
CRF 250	14-17	WP99157	○ ● ○
CRF 450	05-08		● ● ○
CRF 450	09-12	WP94127	● ● ○
CRF 450	13-16		○ ● ○
CRF 450	2017	WP99232	● ● ○ ●
CRF-X 450	08-17	WP99104	●
SIDE PANELS (PAIR)			
CR 85	03-07	WP96021	○
CR 125 / 250	02-07	WP96007	○ ●
CRF 150R	07-17	WP96040	○
CRF 250	04-05	WP96018	○ ●
CRF 250	06-09	WP96028	○ ● ● ●
CRF 250 (AIRBOX PANELS)	10-13	WP96045	● ● ○
CRF 250 (AIRBOX PANELS)	14-17	WP99160	○ ● ●
CRF 250	10	WP96047	○ ● ●
CRF 250	11-13	WP96055	○ ● ●
CRF 250	14-17	WP99158	○ ● ●
CRF-X 250	04-17	WP99105	○
CRF 450	05-06	WP96026	○ ● ●
CRF 450	07-08	WP96039	○ ● ● ●
CRF 450	09-10	WP96047	○ ● ● ●
CRF 450	11-12	WP96055	○ ● ● ●
CRF 450	13-16	WP99158	○ ● ● ●
CRF 450 / CRF-RX 450	2017	WP99233	○ ● ● ●
CRF 450 (AIRBOX PANELS)	09-12	WP96045	○ ● ● ●
CRF 450 (AIRBOX PANELS)	13-16	WP99160	○ ● ● ●
CRF 450 / CRF-RX 450 (AIRBOX PANELS)	2017	WP99235	● ● ○
CRF-X 450	05-17	WP99106	○
XR 250 / 400	96-08	WP94180	○

OEM ALTERNATIVE PARTS, INJECTED HIGH QUALITY PLASTIC, SHINING ORIGINAL MATCHING COLOURS

HONDA



MODEL	YEAR	P/N	COLOURS
REAR FENDER			
CR 80 / 85	96-07	WP95634	●
CR 125 / 250	02-07	WP95606	● ●
CRF 150R	07-17	WP95691	●
CRF 250	04-05	WP95627	● ○
CRF 250	06-07	WP95511	● ● ○
CRF 250	08-09	WP95501	● ○ ●
CRF 250	10-13	WP95787	○ ● ●
CRF 250	14-17	WP99156	○ ● ●
CRF-X 250 (LED NOT INCLUDED)	04-17	WP99101	●
CRF 450	05-08	WP95653	● ● ○
CRF 450	09-12	WP95787	○ ● ●
CRF 450	13-16	WP99156	○ ● ●
CRF 450 / CRF-RX 450	2017	WP99231	● ● ○
CRF-X 450 (LED NOT INCLUDED)	05-17	WP99102	○
XR 250 / 400	96-08	WP95940	○
SWINGARM PROTECTOR / CHAIN SLIDER			
CRF 150R	07-17	WP99108	●
CR 125 / 250 / 500 - CRF 250 / 450	00-08	WP94500	●
CRF 250	04-09		●
CRF 250	10-13	WP94901	●
CRF 250	14-17	WP99175	●
CRF-X 250 / 450	04-17		●
CRF 450	02-08	WP94500	●
CRF 450	09-12	WP94901	●
CRF 450	13-16	WP99175	●
CRF 450 / CRF-RX 450	2017	WP99236	●
REAR SPROCKET CHAIN GUIDE			
CR 125 / 250 / 500 - CRF 250 / 450 - CRF-X 250 / 450	05-06	WP94514	●
CRF 150R	07-17	WP99107	●
CRF 250 / 450 - CRF-X 250 / 450 - CRF-RX 450	07-17	WP94351	●
REAR SHOCK PROTECTION			
CRF 150R	07-16	WP99057	●
CR 125 / 250 / 500	93-07	WP99050	●
CRF 250	06-09	WP99058	●
CRF 250	10-13		●
CRF-X 250 / 450	04-16	WP99050	●
CRF 450	02-12		●
CRF 250	14-16	WP99161	●
CRF 450	13-16		●
CRF 450 / CRF-RX 450	2017	WP99237	●

WRP STREET

- CONTROLS
- BRAKE PADS
- CHAINS
- CANOPIES / TENTS

WRP OFF-ROAD

- CONTROLS
- BEARINGS & COMPONENTS
- BRAKE DISCS
- BRAKE PADS
- CHAINS
- SPROCKETS
- PROTECTIONS
- AIR & OIL FILTERS
- PLASTICS
- CANOPIES / TENTS



OEM ALTERNATIVE PARTS, INJECTED HIGH QUALITY PLASTIC, SHINING ORIGINAL MATCHING COLOURS



HUSQVARNA



MODEL	YEAR	P/N	COLOURS
FORK PROTECTORS (PAIR)			
CR/WR / TC/TE/SMR/SMRR ALL CC	08-13	WP99119	○ ●
TC/FC 125/250/350/450	2014	WP99189	●
TE/FE 125/250/300/350/450/501	14-15	WP99190	●
TC/FC 125/250/350/450	2015	WP99190	●
TC/FC/TE/FE 125/250/300/350/450	2016	WP99228	○
TC/FC/TE/FE 125/250/300/350/450	2017	WP99228	● ○
FRONT NUMBER PLATE			
CR 125/250 / TC 250	05-13	WP96582	○ ●
TC/SMR 450/510	05-10	WP99118	○ ●
TC 449/511	11-13	WP99118	○
TC/FC 125/250/350/450	14-15	WP99201	○
TC 250	2016	WP99222	○
TC 125 - FC 250/350/450	16-17	WP99222	○
TC/TX 250/300 - FS/FX 350/450	2017	WP99222	○
FRONT FENDER			
CR/WR 125/250/300 / TC/TE 250/310	05-13	WP95676	○
TC/TE 450/510	05-10	WP99110	○
TC/TE/SMR 449/511	11-13	WP99110	○ ●
TE/FE 125/250/300/350/450/501	2014	WP99176	○
TE/FE 125/250/300/350/450/501	15-16	WP99177	○
TC/FC 125/250/350/450	14-15	WP99177	○
TC 250	2016	WP99223	○
TC 125 - FC 250/350/450	16-17	WP99223	○
TC/TX 250/300 - FS/FX 350/450	2017	WP99223	○
TE/FE 250/300/350/450/501	2017	WP99223	○
FRONT FENDER SUPPORT			
CR/WR 125/250/300 / TC/TE 250/310	05-13	WP95507	●
TC/TE 450/510	05-10	WP95507	●
TANK COVERS+RADIATOR SCOOPS (PAIR)			
CR/WR 125	05	WP94268	●
CR/WR 250/300	05-13	WP94268	●
TC/TE 250/310/450/510	05-07	WP94141	●
CR/WR 125	06-08	WP94141	●
TC 250	08	WP94141	●
TE 250	08-09	WP94141	●
TC/TE/SMR/SMRR 310/450/510/530	08-10	WP94141	●
CR/WR 125	09-13	WP99111	●
TC 250	09-12	WP99111	●
TE 250	10-13	WP99111	●
TE 310	11-12	WP99130	●
TC/TE/SMR 449/511	11-13	WP99130	●
RADIATOR COVERS (PAIR)			
TC/TE 250/310/450/510	05-07	WP94269	●
CR/WR 125	05-08	WP99112	●
CR/WR 250/300	06-13	WP99112	●
TC 250	08	WP94142	●
TE 250	08-09	WP94142	●
TC/TE/SMR/SMRR 310/450/510/530	08-10	WP99113	●
CR/WR 125	09-13	WP99113	●
TC 250	09-13	WP99113	●
TE 250	10-13	WP99113	●
TE 310	11-13	WP99178	○ ●
TC/TE/FE/FC 125/250/300/350/450/501	2014	WP99178	○ ● ●
TC/TE/FE/FC 125/250/300/350/450/501	2015	WP99178	○ ● ● ●
TC 250 - TE/FE 125/250/300/350/450/501	2016	WP99224	○ ● ● ●
TC 125 - FC 250/350/450	2016	WP99224	○ ● ●
TE/FE 250/300/350/450/501	2017	WP99224	○ ● ●
TC/TX 125/250/300 - FC/FS/FX 250/350/450	2017	WP99224	○ ● ●
SIDE PANELS (PAIR)			
CR/WR 125	05-08	WP96032	○
CR/WR 250/300	06-13	WP96032	○
TC/TE 250/310/450/510	05-07	WP99114	○
CR/WR 125	09-13	WP99114	○
TC/TE 250/310	08-13	WP96012	○ ●
TC/TE 450/510	08-10	WP96012	○ ●
TC/TE/SMR 449/511	11-13	WP99115	●
TC/TE/FE/FC 125/250/300/350/450/501	14-15	WP99179	○
TC 250 - TE/FE 125/250/300/350/450/501	2016	WP99179	○

OEM ALTERNATIVE PARTS, INJECTED HIGH QUALITY PLASTIC, SHINING ORIGINAL MATCHING COLOURS

HUSQVARNA

MODEL	YEAR	P/N	COLOURS
SIDE PANELS (PAIR)			
TC 125 - FC 250/350/450	16-17		○
TC/TX 250/300 - FS/FX 350/450	2017	WP99225	○
TE/FE 250/300/350/450/501	2017		○
REAR FENDER			
CR/WR 125	05-08		○
CR/WR 250/300	06-13	WP95677	○
TC/TE 250/310/450/510	05-07		○
CR/WR 125	09-13	WP99116	○
TC/TE 250/310	08-13		○
TC/TE 450/510	08-10	WP95503	○
TC/TE 449/511	11-13	WP99117	○
TC/TE 449/511 (UNDER TAIL - PAIR)	11-13	WP99165	●
TE/FE 125/250/300/350/450/501	14-16	WP99180	○
TC 125 - FC 250/350/450	14-15		○
TC 250	14-16	WP99226	○
TC 125 - FC 250/350/450	2016		● ○
TC 125 - FC 250/350/450	2017	WP99227	○ ●
TC/TX 250/300 - FS/FX 350/450	2017		○ ●
TX 125 - TE/FE 250/300/350/450/501	2017	WP99229	○
SWINGARM PROTECTOR / CHAIN SLIDER			
TC/TE/FE/FC/FS/FX 125/250/300/350/450/501	14-17	WP99133	●
REAR SPROCKET CHAIN GUIDE			
TE/FE 125/250/300/350/450/501	14-17	WP99170	●
TX 125	2017		●
TC/FC 125/250/350/450	15-17		●
TX/FX/FS 300/350/450	2017	WP99220	●
REAR SHOCK PROTECTION			
TC/TE 449/511	11-13	WP99166	●
TC/FC 125/250/350/450	14-15	WP99128	●
TC 250 - TE/FE 125/250/300/350/450/501	2016		●
TC 125 - FC 250/350/450	16-17		●
TC/TX 125/250/300 - TE/FE/FS/FX 125/250/300/350/450	2017	WP99221	●



WRP STREET

- CONTROLS
- BRAKE PADS
- CHAINS
- CANOPIES / TENTS

WRP OFF-ROAD

- CONTROLS
- BEARINGS & COMPONENTS
- BRAKE DISCS
- BRAKE PADS
- CHAINS
- SPROCKETS
- PROTECTIONS
- AIR & OIL FILTERS
- PLASTICS
- CANOPIES / TENTS



OEM ALTERNATIVE PARTS, INJECTED HIGH QUALITY PLASTIC, SHINING ORIGINAL MATCHING COLOURS



KAWASAKI



MODEL	YEAR	P/N	COLOURS
FORK PROTECTORS (PAIR)			
KX 85 - KX 100	01-13	WP99129	○
KX 85 - KX 100	14-17	WP99191	●
KX 125 / 250 - KX 250F	04-05	WP93980	○ ●
KX 125 / 250	07-08		○ ●
KX 250F / 450F	06-08	WP93512	○ ●
KLX-R 450	07-16		○ ●
KX 250F	09-16		● ○
KX 450F	09-15	WP93518	● ○
KX 250F	2017		○ ○
KX 450F	16-17	WP99202	● ○
FRONT NUMBER PLATE			
KX 65	01-17		○ ●
KLX 110	02-09	WP96615	○ ●
KX 85 - KX 100	01-13	WP96617	○ ● ●
KX 85 - KX 100	14-17	WP99192	○
KX 125 / 250	03-08		○ ●
KX 250F / 450F	04-08	WP96608	○ ●
KX 250F	09-12		● ○
KX 450F	09-12	WP96568	○ ●
KX 250F	13		● ○
KX 250F	14-16	WP99164	○ ●
KX 450F	13-15		○ ●
KX 250F	2017		○
KX 450F	16-17	WP99203	○
FRONT FENDER			
KX 65	01-17	WP95616	● ●
KX 85 / 100	98-13	WP95603	● ●
KX 85 / 100	14-17	WP99193	●
KX 125 / 250	03-08		● ●
KX 250F / 450F	04-08	WP95610	● ●
KLX-R 450	07-16		● ●
KX 250F / 450F	09-12	WP95728	● ●
KX 250F	13-16		● ●
KX 450F	13-15	WP99162	● ●
KX 250F	2017		● ●
KX 450F	16-17	WP99204	● ●
RADIATOR COVERS (PAIR)			
KX 65	01-17		●
KLX 110	02-09	WP94293	●
KX 85 - KX 100	98-13	WP94250	● ●
KX 85 - KX 100	14-17	WP99194	●
KX 125 / 250	03-08	WP94291	● ●
KX 250F	04-05	WP94105	●
KX 250F	06-07	WP94262	● ● ● ●
KX 250F	08	WP94262	● ●
KX 250F	09-12	WP94128	● ● ● ●
KX 250F	13-16	WP99163	● ● ● ●
KX 250F	2017	WP99238	● ● ● ●
KX 450F	06-07	WP94263	● ● ● ●
KX 450F	08	WP94263	● ● ● ●
KX 450F	09-11	WP94129	● ● ● ●
KX 450F	12-15	WP99143	● ● ● ●
KX 450F	16-17	WP99205	● ● ● ●
SIDE PANELS (PAIR)			
KX 65	01-17		○ ●
KLX 110	02-09	WP96014	○ ●
KX 85 - KX 100	98-13	WP96005	○ ● ●
KX 85 - KX 100	14-17	WP99195	○
KX 125 / 250	03-08	WP96011	○ ● ●
KX 250F	04-05	WP96019	○ ●
KX 250F	06-08	WP96030	○ ●
KX 250F	09-12	WP96048	● ○ ● ●
KX 250F	13-16	WP99144	○ ● ● ●
KX 250F	2017	WP99206	○ ● ● ●
KX 450F	06-08	WP96031	○ ● ● ●
KX 450F	09-11	WP96048	○ ● ● ●
KX 450F	12-15	WP99144	○ ● ● ●
KX 450F	16-17	WP99206	○ ● ● ●

OEM ALTERNATIVE PARTS, INJECTED HIGH QUALITY PLASTIC, SHINING ORIGINAL MATCHING COLOURS

KAWASAKI



MODEL	YEAR	P/N	COLOURS
REAR FENDER			
KX 65	01-17		● ○
KLX 110	02-09	WP95615	● ○
KX 85 / 100	98-13	WP95604	● ●
KX 85 / 100	14-15		○ ●
KX 85 / 100	16-17	WP99196	● ○
KX 125 / 250	03-08	WP95611	● ●
KX 250F	04-05	WP95629	● ●
KX 250F / 450F	06-08	WP95512	● ●
KX 250F / 450F	09-11	WP95788	● ●
KX 250F	12	WP95788	● ●
KX 250F	2013		● ● ○
KX 250F	14-15		○ ● ●
KX 250F	2016	WP99136	● ● ○
KX 450F	12		● ● ○
KX 450F	13-15		○ ● ●
KX 250F	2017		● ● ○
KX 450F	16-17	WP99207	● ● ○
SWINGARM PROTECTOR / CHAIN SLIDER			
KX 125 / 250 / 500	04-08	WP94521	●
KX 250F	04-05	WP94518	●
KX 250F / 450F	06-08		●
KLX-R 450	07-16	WP94523	●
KX 250F	09-16	WP94902	●
KX 250F	2017	WP99239	●
KX 450F	09-15	WP94902	●
KX 450F	16-17	WP99239	●
REAR SPROCKET CHAIN GUIDE			
KX 125 / 250	03-08		●
KX 250F	04-05	WP94519	●
KX 250F / 450F	06-08		●
KLX-R 450	07-16	WP94524	●
KX 250F / 450F	09-17	WP94903	●
REAR SHOCK PROTECTION			
KX 125 / 250 / 500	91-08	WP99053	●
KXF 250	04-16		●
KXF 450	04-15	WP99054	●
KLX-R 450	07-16		●
KXF 250	2017		●
KXF 450	16-17	WP99208	●

WRP STREET

- CONTROLS
- BRAKE PADS
- CHAINS
- CANOPIES / TENTS

WRP OFF-ROAD

- CONTROLS
- BEARINGS & COMPONENTS
- BRAKE DISCS
- BRAKE PADS
- CHAINS
- SPROCKETS
- PROTECTIONS
- AIR & OIL FILTERS
- PLASTICS
- CANOPIES / TENTS



OEM ALTERNATIVE PARTS, INJECTED HIGH QUALITY PLASTIC, SHINING ORIGINAL MATCHING COLOURS



KTM

MODEL	YEAR	P/N	COLOURS
FORK PROTECTORS (PAIR)			
EXC - SX - SXF 125 > 525	00-07	WP93990	● ●
EXC - SX - SXF 125 > 530	08-10		● ● ●
EXC - EXCF 125 > 530	11-15	WP93984	● ● ● ●
SX - SXF 125 > 505	11-14		● ● ● ●
SX - SXF 125 > 450	15-16		● ● ● ●
EXC - EXCF 125 > 450	2016	WP99197	● ● ● ●
SX - SXF 125 > 450	2017		● ● ● ●
EXC - EXCF - XC 125 > 450	2017		● ● ● ●
FRONT NUMBER PLATE			
SX 65	02-08	WP96616	● ●
SX 65	09-15	WP96647	● ●
SX 65	16-17	WP99209	● ●
SX 85	04-12	WP96624	● ● ●
SX 85	13-17	WP99210	● ● ● ●
SX - SXF 125 / 200 / 250 / 450 / 525	03-06	WP96609	● ● ● ● ●
SX - SXF 125 / 144 / 250 / 350 / 450 / 505	07-12	WP96644	● ● ● ● ● ●
SX 125 / 150 - SXF 250 / 350 / 450	13-15	WP99154	● ● ● ● ●
SX 250	13-16		● ● ● ● ●
SX 125 / 150 - SXF 250 / 350 / 450	16-17	WP99211	● ● ● ● ●
SX 250 - XC / XCF 250 / 300 / 350 / 450	2017		● ● ● ● ●
FRONT FENDER			
SX 65	02-08	WP95617	● ● ●
SX 65	09-11	WP95715	● ● ●
SX 65	12-15	WP99146	● ● ●
SX 65	16-17	WP99212	● ● ●
SX 85	04-12	WP95638	● ● ●
SX 85	13-17	WP99147	● ● ●
SX 125 / 200 / 250 / 250F / 400 / 450 / 520 / 525	99-06	WP95612	● ● ● ● ● ●
EXC 125 / 200 / 250 / 250F / 300 / 400 / 450 / 520 / 525	99-07		● ● ● ● ● ●
SX - SXF 125 / 144 / 150 / 250 / 350 / 450 / 505	07-12	WP95687	● ● ● ● ● ●
EXC - EXCF 125 / 200 / 250 / 300 / 350 / 400 / 450 / 500 / 530	08-13		● ● ● ● ● ●
SX 125 / 150 - SXF 250 / 350 / 450	13-15	WP99148	● ● ● ● ● ●
SX 250	13-16		● ● ● ● ● ●
EXC - EXCF 125 / 200 / 250 / 300 / 350 / 450 / 500	14-16	WP99213	● ● ● ● ● ●
SX 125 / 150 - SXF 250 / 350 / 450	16-17		● ● ● ● ● ●
SX 250	2017	WP99213	● ● ● ● ● ●
EXC-EXCF-XC-XCF 125 / 200 / 250 / 300 / 350 / 450 / 500	2017		● ● ● ● ● ●
RADIATOR COVERS (PAIR)			
SX 65	02-08	WP94295	● ●
SX 65	09-15	WP94124	● ● ●
SX 65	2016	WP99214	● ● ● ●
SX 65	2017		● ● ● ●
SX 85	06-12	WP94283	● ● ●
SX 85	13-14	WP99150	● ● ● ● ● ●
SX 85	15-16		● ● ● ● ● ●
SX 85	2017	WP94115	● ● ● ● ● ●
SX 125 / 200 / 250 / 450 / 525	05-06		● ● ● ● ● ●
EXC 125 / 200 / 250 / 250F / 300 / 450 / 525	05-07	WP94282	● ● ● ● ● ●
SX - SXF 125 / 250 / 450 / 505	07-10		● ● ● ● ● ●
EXC - EXCF 125 / 200 / 250 / 300 / 400 / 450 / 530	08-09	WP94286	● ● ● ● ● ●
EXC - EXCF 125 / 200 / 250 / 300 / 400 / 450 / 530	10-11		● ● ● ● ● ●
SX - SXF 125 / 150 / 250 / 350 / 450	11-12	WP94286	● ● ● ● ● ●
EXC - EXCF 125 / 200 / 250 / 300 / 350 / 450 / 500	12-13		● ● ● ● ● ●
SX - SXF 125 / 150 / 250 / 350 / 450	13-14	WP99151	● ● ● ● ● ● ● ●
EXC - EXCF 125 / 200 / 250 / 300 / 350 / 450 / 500	2014		● ● ● ● ● ● ● ●
SX 125 / 150 - SXF 250 / 350 / 450	2015	WP99215	● ● ● ● ● ● ● ●
SX 250	15-16		● ● ● ● ● ● ● ●
EXC - EXCF 125 / 200 / 250 / 300 / 350 / 450 / 500	15-16	WP99215	● ● ● ● ● ● ● ●
SX 125 / 150 - SXF 250 / 350 / 450	2016		● ● ● ● ● ● ● ●
SX 125 / 150 / 250 - SXF 250 / 350 / 450	2017	WP99215	● ● ● ● ● ● ● ●
EXC - EXCF - XC 125 / 200 / 250 / 300 / 350 / 450 / 500	2017		● ● ● ● ● ● ● ●
SIDE PANELS (PAIR)			
SX - SXF 125/150/250/350/450 (SINGLE LEFT AIRBOX COVER)	11-12	WP94030-SX	● ● ● ● ●
EXC - EXCF 125 > 500 (SINGLE LEFT AIRBOX COVER)	12-13		● ● ● ● ●
SX 125 / 150 / 250 (SINGLE RIGHT AIRBOX COVER)	11	WP99132-DX	● ● ● ● ●
EXC - EXCF 125 > 500 (SINGLE RIGHT AIRBOX COVER)	12-13		● ● ● ● ●
SX 125 / 250 (SINGLE RIGHT AIRBOX COVER)	12	WP94030-DX	● ● ● ● ●
SXF 250 / 350 / 450 (SINGLE RIGHT AIRBOX COVER)	11-12		● ● ● ● ●
SX 125 / 150 / 250 (LEFT+RIGHT AIRBOX COVERS KIT)	11	WP99132	● ● ● ● ● ●
EXC - EXCF 125 > 500 (LEFT+RIGHT AIRBOX COVERS KIT)	12-13		● ● ● ● ● ●
SX 125 / 250 (LEFT+RIGHT AIRBOX COVERS KIT)	12	WP94030	● ● ● ● ● ●
SXF 250 / 350 / 450 (LEFT+RIGHT AIRBOX COVERS KIT)	11-12		● ● ● ● ● ●
SX - SXF 125 / 150 / 250 / 350 / 450 (SIDE PANELS & AIRBOX FLANGE)	11-12	WP99152	● ● ● ● ● ●
EXC - EXCF 125 > 500 (SIDE PANELS & AIRBOX FLANGE)	12		● ● ● ● ● ●



KTM

MODEL	YEAR	P/N	COLOURS
SIDE PANELS (PAIR)			
EXC - EXCF 125 > 500 (SINGLE LEFT AIRBOX COVER)	2014	WP99153-SX	●●●●
EXC - EXCF 125 > 500 (SINGLE LEFT AIRBOX COVER)	15-16		●●●●
EXC - EXCF 125 > 500 (SINGLE RIGHT AIRBOX COVER)	2014	WP99167-DX	●●●●
EXC - EXCF 125 > 500 (SINGLE RIGHT AIRBOX COVER)	15-16		●●●●
EXC - EXCF 125 > 500 (LEFT+RIGHT AIRBOX COVERS KIT)	2014	WP99167	●●●●
EXC - EXCF 125 > 500 (LEFT+RIGHT AIRBOX COVERS KIT)	15-16		●●●●
EXC - EXCF - XC 125 > 500 (LEFT+RIGHT SIDE PANELS)	2017	WP99216	○●●●
EXC - EXCF - XC 125 > 500 (SINGLE LEFT AIRBOX PANEL)	2017	WP99217	●●●●
SX - SXF 125/150/250/350/450 (SINGLE LEFT AIRBOX COVER)	13-14		●●●●
SX 125/150 - SXF 250/350/450 (SINGLE LEFT AIRBOX COVER)	2015	WP99153-SX	●●●●
SX 250	15-16		●●●●
SX - SXF 125/150/250/350/450 (SINGLE RIGHT AIRBOX COVER)	13-14		●●●●
SX 125/150 - SXF 250/350/450 (SINGLE RIGHT AIRBOX COVER)	2015	WP99153-DX	●●●●
SX 250	15-16		●●●●
SX - SXF 125 > 450 (LEFT+RIGHT AIRBOX COVERS KIT)	13-14		●●●●
SX 125/150 - SXF 250>450 (LEFT+RIGHT AIRBOX COVERS KIT)	2015	WP99153	●●●●
SX 250	15-16		●●●●
SX 125/150 - SXF 250>450 (LEFT+RIGHT SIDE PANELS)	16-17	WP99216	○●●●
SX 125/150 - SXF 250>450 (SINGLE LEFT AIRBOX PANEL)	16-17	WP99217	○●●●
SX 250 (SINGLE LEFT AIRBOX PANEL)	2017		○●●●
SX-SXF-EXC-EXCF 125>500 (SIDE PANELS & AIRBOX FLANGE)	13-15	WP99152	○●●●
SX 250	2016		○●●●
REAR FENDER			
SX 65	16-17	WP99218	○
SX 85	13-17	WP99149	●
SX - SXF 125 / 150 / 250 / 350 / 450	11-12		○●●●
SX 125 / 150 - SXF 250 / 350 / 450	13-15	WP95954	●●●●
SX 250	13-16		●●●●
SX 125 / 150 - SXF 250 / 350 / 450	2016		○●●●
SX 125 / 150 / 250 - SXF 250 / 350 / 450	2017	WP99219	●●●●
XC / XCF 250 / 300 / 350 / 450	2017		●●●●
EXC - EXCF 125 / 200 / 250 / 300 / 350 / 450 / 500	12-16	WP99145	●●●●
EXC - EXCF 125 / 200 / 250 / 300 / 350 / 450 / 500	2017	WP99240	●●●●
REAR FENDER W/ SIDE PANELS			
SX 65	02-08	WP95618	●●
SX 65	09-15	WP95716	●
SX 85	04-12	WP95639	●
SX 200 / 250 / 450	03-06		●●
SX - SXF 125 / 250 / 450 / 525	04-06	WP95613E	●●●
EXC 125 / 200 / 250 / 250F / 300 / 400 / 450 / 525	04-07	WP95613E	●●●○
SX - SXF 125 / 144 / 150 / 250	07-10		●●●○
SXF 250 / 450 / 505	07-10	WP95679	●●●○
EXC - EXCF 125 / 250 / 300 / 450 / 530	08-11	WP99124	○●●●
SWINGARM PROTECTOR / CHAIN SLIDER			
SX - SXF 125 > 525	97-06		●
EXC 125 > 525	97-07	WP94513	●
SX - SXF 125 > 505	07-10		●
EXC 125 > 530	08-11	WP94526	●
SX - SXF 125 > 450	11-17	WP99133	●
EXC - EXCF 125 > 500	12-17	WP99168	●
REAR SPROCKET CHAIN GUIDE			
SX 85	04-14	WP94512	●
SX 85	15-17	WP99170	●
SX - SXF 125 > 525	94-06		●
EXC 125 > 525	94-07	WP94512	●
SX - SXF 125 > 505	07		●
EXC - EXCF 125 > 530	08-13	WP94900	●
EXC - EXCF 125 > 500	14-17	WP99170	●
SX - SXF 125 > 450	08-13	WP99134	●
SX - SXF 125 > 450	2014	WP99169	●
SX - SXF 125 > 450	15-17	WP99220	●
REAR SHOCK PROTECTION			
SX - SXF 125 > 525	98-06		●
EXC - EXCF 125 > 525	98-07	WP99127	●
SX 125 / 150 - SXF 250 > 450	07-15		●
SX 250	07-16	WP99128	●
EXC - EXCF 125 > 530	08-15		●
SX 125 / 150 - SXF 250 > 450	16-17		●
SX 250	2017	WP99221	●
EXC - EXCF - XC 125 > 525	2017		●

WRP STREET

- CONTROLS
- BRAKE PADS
- CHAINS
- CANOPIES / TENTS

WRP OFF-ROAD

- CONTROLS
- BEARINGS & COMPONENTS
- BRAKE DISCS
- BRAKE PADS
- CHAINS
- SPROCKETS
- PROTECTIONS
- AIR & OIL FILTERS
- PLASTICS
- CANOPIES / TENTS





SUZUKI



MODEL	YEAR	P/N	COLOURS
FORK PROTECTORS (PAIR)			
RM-Z 250	04-06	WP93980	○ ●
RM 125 / 250	04-06	WP99138	○
RM-Z 450	05-06		○
RM 125 / 250 - RM-Z 250 / 450	07-17	WP93983	● ○
RMX-Z 450	07-17		● ○
FRONT NUMBER PLATE			
RM 65 / DRZ 110	03-07	WP96615	○ ●
RM 85	03-15	WP96630	○
RM 85	16-17		○
RM 125 / 250	01-11	WP96604	○ ● ●
RM-Z 250	04-06	WP96608	○ ● ●
RM-Z 250	07-09	WP96604	○ ● ●
RM-Z 250	10-17	WP96627	● ● ○
RM-Z 450	05-07	WP96604	○ ● ●
RM-Z 450	08-17	WP96627	● ● ○
FRONT FENDER			
RM 65	03-07	WP95616	● ●
RM 80 / 85	96-17	WP95628	●
RM 125 / 250	01-11	WP95601	● ●
RM-Z 250	04-06	WP95610	● ●
RM-Z 250	07-09	WP95601	● ●
RM-Z 250	10-17	WP95505	● ●
DRZ 400	00-09	WP95601	● ●
RM-Z 450	05-07		● ●
RM-Z 450	08-17	WP95505	● ●
RMX-Z 450	10-17		● ●
RADIATOR COVERS (PAIR)			
RM 65 - DRZ 110	03-07	WP94293	●
RM 85 (SINGLE)	02-17	WP94107	●
RM 125 / 250	01-08	WP94230	● ●
RM-Z 250	04-06	WP94104	● ●
RM-Z 250	07-09	WP94284	● ●
RM-Z 250	10-17	WP94136	● ●
RM-Z 450	05-06	WP94114	● ●
RM-Z 450	07	WP94285	● ●
RM-Z 450	08-17	WP94125	● ● ● ●
RMX-Z 450	10-17		● ● ● ●
SIDE PANELS (PAIR)			
RM 65 - DRZ 110	03-07	WP96014	○ ● ●
RM 80 / 85	96-15	WP96022	○ ● ●
RM 85	2016		○ ● ●
RM 85	2017		○ ● ●
RM 125 / 250	01-11	WP96004	○ ●
RM-Z 250	04-06	WP96019	○ ●
RM-Z 250	07-09	WP96037	○ ● ●
RM-Z 250	10-12	WP96052	● ● ● ●
RM-Z 250	2013		○ ● ● ●
RM-Z 250	14-16		○ ● ● ●
RM-Z 250	2017		○ ● ● ●
RM-Z 450	05-07		WP96038
RM-Z 450	08-13	WP96015	○ ● ●
RM-Z 450	14-16		○ ● ●
RM-Z 450	2017		○ ● ●
REAR FENDER			
RM 65 - DRZ 110	03-07	WP95615	●
RM 80 / 85	96-15	WP95656	● ●
RM 85	2016		● ●
RM 85	2017		● ●
RM 125 / 250	01-08	WP95602	● ●
RM-Z 250	04-06	WP95629	● ●
RM-Z 250	07-09	WP95688	● ●
RM-Z 250	10-12	WP95529	● ● ○
RM-Z 250	13-16		● ● ○
RM-Z 250	2017		● ● ○
RM-Z 450	05-07	WP95655	● ●
RM-Z 450	08-12	WP95525	● ●
RM-Z 450	13-16		● ●
RM-Z 450	2017		● ●
RMX-Z 450	10-17	WP99137	●

SUZUKI



MODEL	YEAR	P/N	COLOURS
SWINGARM PROTECTOR / CHAIN SLIDER			
RM 125 / 250	01-11	WP94516	●
RM-Z 250	04-06	WP94518	●
RM-Z 250	07-09	WP94516	●
RM-Z 250	10-17	WP99139	●
RM-Z 450	05-06	WP94516	●
RM-Z 450	07	WP99139	●
RM-Z 450	08-09	WP94516	●
RM-Z 450	10-17	WP99139	●
RMX-Z 450	10-17	WP94516	●
REAR SPROCKET CHAIN GUIDE			
RM 125 / 250	05-11	WP94517	●
RM-Z 250	04-06	WP94519	●
RM-Z 250	07-17	WP94517	●
RM-Z / RMX-Z 450	05-17		●
REAR SHOCK PROTECTION			
RM 125 / 250	96-11	WP99052	●
RM-Z 250	07-17		●
RM-Z / RMX-Z 450	05-17		●

WRP STREET

- CONTROLS
- BRAKE PADS
- CHAINS
- CANOPIES / TENTS

WRP OFF-ROAD

- CONTROLS
- BEARINGS & COMPONENTS
- BRAKE DISCS
- BRAKE PADS
- CHAINS
- SPROCKETS
- PROTECTIONS
- AIR & OIL FILTERS
- PLASTICS
- CANOPIES / TENTS



OEM ALTERNATIVE PARTS, INJECTED HIGH QUALITY PLASTIC, SHINING ORIGINAL MATCHING COLOURS



YAMAHA



MODEL	YEAR	P/N	COLOURS
FORK PROTECTORS (PAIR)			
YZ 125 / 250 - YZF 250 / 450	05-07	WP93981	○ ●
WRF 250 / 450 (HAS NO SPEEDOMETER CABLE GUIDE)	05-17		○ ●
YZ 125 / 250	08-14	WP93909	○ ●
YZF 250 / 450	08-09		○ ●
YZ 125 / 250	15-17	WP93520	○ ●
YZF 250 / 450	10-17		○ ●
FRONT NUMBER PLATE			
YZ 80 / 85	98-14	WP96623	○
YZ 85	15-17	WP99188	○
YZ 125 / 250	00-05	WP96580	○ ●
YZF 250	01-05		○ ●
YZF 426	00-02		○ ●
YZF 450	03-05		○ ●
YZ 125 / 250	06-14	WP96581	○ ● ●
YZF 250 / 450	06-09		○ ● ●
YZ 125 / 250	15-17	WP96784	○ ● ●
YZF 250 / 450	10-17		○ ● ●
FRONT FENDER			
YZ 80 / 85	98-14	WP95635	●
YZ 85	15-17	WP99181	●
YZ - WR 125 / 250	00-05	WP95522	● ● ● ○
YZF - WRF 250	01-05		● ● ● ○
YZF 426 - WRF 400 / 426	00-02		● ● ● ○
YZF 450 / WRF 450	03-05		● ● ● ○
YZ - WR - WRF 125 / 250	06-14	WP95513	● ● ● ○
WRF 450	06-11		● ● ● ○
YZF 250 / 450	06-09	WP95536	● ● ● ○
YZ - 125 / 250	15-17		● ● ● ○
WRF 250	15-17		● ● ● ○
WRF 450	12-17		● ● ● ○
YZF 250 / 450	10-17		● ● ● ○
RADIATOR COVERS (PAIR)			
YZ 85 (SINGLE)	02-14	WP94109	●
YZ 85 (SINGLE)	15-17	WP99182	●
YZ 125 / 250	02-14	WP94260	● ●
YZ 125 / 250	15-17	WP99183	●
YZF 250 / 450	03-05	WP94292	●
WRF 250 / 450	05-06		●
YZF 250 / 450	06-09	WP94261	● ● ● ○
YZF 250	10-13	WP94137	● ● ● ● ● ○
YZF 450 (UPPER RADIATOR+TANK COVER)	10-13	WP94138U	● ● ● ● ● ○
YZF 450 (LOWER RADIATOR COVER)	10-13	WP94138D	○ ● ● ● ● ○
YZF 450 (COVERS COMPLETE KIT)	10-13	WP94138	● ● ● ● ● ○
YZF 250 / 450 (UPPER RADIATOR+TANK COVER)	14-17	WP99172U	● ● ● ● ● ○
WRF 250 (UPPER RADIATOR+TANK COVER)	15-17		● ● ● ● ● ○
WRF 450 (UPPER RADIATOR+TANK COVER)	16-17		● ● ● ● ● ○
YZF 250 / 450 (LOWER RADIATOR COVER)	14-17		○ ● ● ● ● ○
WRF 250 (LOWER RADIATOR COVER)	15-17	WP99172D	○ ● ● ● ● ○
WRF 450 (LOWER RADIATOR COVER)	16-17		○ ● ● ● ● ○
YZF 250 / 450 (COVERS COMPLETE KIT)	14-17	WP99172	● ● ● ● ● ○
WRF 250 (COVERS COMPLETE KIT)	15-17		● ● ● ● ● ○
WRF 450 (COVERS COMPLETE KIT)	16-17		● ● ● ● ● ○
WRF 250	07-13		WP94329
WRF 450	07-11	● ● ● ● ● ○	
WRF 450	12-15	WP94137	

YAMAHA



MODEL	YEAR	P/N	COLOURS
SIDE PANELS (PAIR)			
YZ 85	02-14	WP96024	○
YZ 85	15-17	WP99184	◐
YZ 125 / 250	02-14	WP96006	○ ● ●
YZ 125 / 250	15-17	WP99185	○
YZF 250 / 450	03-05	WP96013	○ ●
YZF 250 / 450	06-09	WP96029	○ ●
YZF 250	10-13	WP96056	◐ ● ●
YZF 450	10-13	WP96044	◐ ● ● ●
YZF 250 / 450	14-17		◐ ● ●
WRF 250	15-17	WP99174	◐ ● ●
WRF 450	16-17		◐ ● ●
WRF 250	07-13		◐ ● ●
WRF 450	07-11	WP96043	◐ ● ●
WRF 450	12-15	WP99173	○ ●
REAR FENDER			
YZ 85	02-12		● ○
YZ 85	13-14	WP95637	○ ●
YZ 85	15-17		● ○
YZ 125 / 250	02-12		● ● ○
YZ 125 / 250	13-14	WP95605	○ ● ●
YZ 125 / 250	15-17	WP99186	●
YZF 250 / 450	03-05	WP95614	●
YZF 250 / 450	06-09	WP95514	● ● ○
YZF 250	10-12		● ● ○
YZF 250	2013	WP95533	○ ● ●
YZF 250	14-17	WP99171	● ● ○
YZF 450	10-12		● ● ○
YZF 450	2013	WP95789	○ ● ●
YZF 450	14-17	WP99171	○ ● ○
WRF 250	07-14		○ ● ●
WRF 450	07-15	WP95694	● ● ○
WRF 250	15-17		●
WRF 450	16-17	WP99187	●
SWINGARM PROTECTOR / CHAIN SLIDER			
YZ - WR 125 / 250 - WRF 250 / 450	05-16		●
YZF 250 / 450	05-08	WP94511	●
YZF 250 / 450	09-17	WP99140	●
REAR SPROCKET CHAIN GUIDE			
YZ 125 / 250 - YZF - WRF 250 / 450	05-06	WP94525	●
YZ 125 / 250 - YZF - WRF 250 / 450	07-17	WP94334	●
REAR SHOCK PROTECTION			
YZ - WR 125 / 250	96-17		●
YZF 250 / 400 / 426 / 450	98-09	WP99051	●
WRF 250 / 400 / 426 / 450	98-17		●
YZF 250	10-17	WP99141	●
YZF 450	10-13	WP99142	●
YZF 450	14-17	WP99141	●

WRP STREET

- CONTROLS
- BRAKE PADS
- CHAINS
- CANOPIES / TENTS

WRP OFF-ROAD



- CONTROLS
- BEARINGS & COMPONENTS
- BRAKE DISCS
- BRAKE PADS
- CHAINS
- SPROCKETS
- PROTECTIONS
- AIR & OIL FILTERS
- PLASTICS
- CANOPIES / TENTS



OEM ALTERNATIVE PARTS, INJECTED HIGH QUALITY PLASTIC, SHINING ORIGINAL MATCHING COLOURS



OFF-ROAD PLASTIC KITS

MAKE / MODEL	KIT P/N	FRONT FENDER	RADIATOR COVERS	SIDE PANELS	REAR FENDER
GAS GAS					
EC 125/200 (05-06)	WP10197	WP95668-RED	WP94264-WHT	WP96036-WHT	WP95669-BLU
EC 250/450 (05-06)	WP10238	WP95668-RED	WP94265-RED	WP96036-WHT	WP95669-BLU
EC 300 (05-06)	WP10198	WP95668-RED	WP94266-BLU	WP96036-WHT	WP95669-BLU
EC 125/200/250/300 / 450 FSE (07)	WP10126	WP95668-RED	WP94326-RED		WP95699-RED
EC 125/200/250/300 / 450 FSE (08) 	WP10199/08	WP95718-BLU	WP94326-RED		WP95699-RED
EC 125/200/250/300 / 450 FSE (09) 	WP10199/09	WP95718-RED	WP94326-BLU		WP95699-BLU
MC / EC / FSR 125/200/250/300/450 (10)	WP10199/10	WP95718-RED	WP94133-RED		WP95508-WHT
MC / EC 125/200/250/300/450 (11)	WP10199/11	WP95953-WHT	WP94133-RED		WP95508-WHT
ECF 250/300 (11-13)	WP10199/11	WP95953-WHT	WP94133-RED		WP95508-WHT
HONDA					
CR 125 / 250 (04-07)	WP10082	WP95626-RED	WP94270-RED	WP96007-WHT	WP95606-RED
CRF 250 (04-05)	WP10083	WP95626-RED	WP94103-RED	WP96018-WHT/RED	WP95627-RED
CRF 250 (06-07)	WP10115	WP95626-RED	WP94103-RED	WP96028-WHT/RED	WP95511-RED
CRF 250 (08)	WP10115/2	WP95626-RED	WP94103-RED	WP96028-WHT/RED	WP95501-RED
CRF 250 (09)	WP10115/3	WP95626-RED	WP94103-RED	WP96028-WHT	WP95501-WHT
CRF 250 (10)	WP10154	WP95727-RED	WP94127-RED	WP96047-WHT	WP95787-WHT
CRF 250 (11-13)	WP10423	WP95727-RED	WP94127-RED	WP96055-WHT	WP95787-WHT
CRF 250 (14-17)	WP10423/13	WP99155-RED	WP99157-RED/WHT	WP99158-WHT	WP99156-WHT
CRF-X 250 (04-17)	WP10200	WP95626-RED	WP94103-RED	WP99105-WHT	WP99101-RED
CRF 450 (05-06)	WP10084	WP95626-RED	WP94113-RED	WP96026-WHT/RED	WP95653-RED
CRF 450 (07-08)	WP10125	WP95626-RED	WP94113-RED	WP96039-WHT/RED	WP95653-RED
CRF 450 (09-10)	WP10154	WP95727-RED	WP94127-RED	WP96047-WHT	WP95787-WHT
CRF 450 (11-12)	WP10423	WP95727-RED	WP94127-RED	WP96055-WHT	WP95787-WHT
CRF 450 (13-16)	WP10423/13	WP99155-RED	WP99157-RED/WHT	WP99158-WHT	WP99156-WHT
CRF 450 (2017)	WP10423/17	WP99230-RED	WP99232-RED/BLK	WP99233-WHT	WP99231-RED
CRF-X 450 (08-17)	WP10202	WP95626-RED	WP99104-RED	WP99106-WHT	WP99102-WHT
HUSQVARNA					
CRWR 125 (05)	WP10226	WP95676-WHT	WP94268-RED	WP96032-WHT	WP95677-WHT
CRWR 125 (06-08)	WP10226/1	WP95676-WHT	WP94141-RED	WP96032-WHT	WP95677-WHT
CRWR 125 (09-13)	WP10226/2	WP95676-WHT	WP99111-RED	WP99114-WHT	WP99116-WHT
CRWR 250/300 (08-13)	WP10226	WP95676-WHT	WP94268-RED	WP96032-WHT	WP95677-WHT
TC/TE 250/450/510 (05-07)	WP10226	WP95676-WHT	WP94268-RED	WP96032-WHT	WP95677-WHT
TC/TE 250/310/450/510 (08)	WP10227	WP95676-WHT	WP94141-RED	WP96012-BLK	WP95503-WHT
TC/TE 250 (09)	WP10228	WP95676-WHT	WP94141-RED	WP96012-WHT	WP95503-WHT
TC/TE/SMR/SMRR310/450/510/530 (09-10)	WP10228	WP95676-WHT	WP94141-RED	WP96012-WHT	WP95503-WHT
TC/TE 250 (10-13) / TE 310 (11-12)	WP10228/1	WP95676-WHT	WP99111-RED	WP96012-WHT	WP95503-WHT
TC/TE 449/511 (11-13)	WP10229	WP99110-WHT/BLK	WP99130-BLK	WP99115-RED	WP99117-WHT
TE/FE 125/250/300/350/450/501 (2014)	WP10410	WP99176-WHT	WP99178-WHT/BLK	WP99179-WHT	WP99180-WHT
TC/FC 125/250/350/450 (2014)	WP10508	WP99177-WHT	WP99178-WHT/BLK	WP99179-WHT	WP99180-WHT
TE/FE 125/250/300/350/450/501 (2015)	WP10598	WP99177-WHT	WP99178-WHT/YLW	WP99179-WHT	WP99180-WHT
TE/FE 125/250/300/350/450/501 (2016)	WP10598/4	WP99177-WHT	WP99178-BLU/YLW	WP99179-WHT	WP99180-WHT
TE/FE 250/300/350/450/501 (2017)	WP10598/5	WP99223-WHT	WP99224-BLU	WP99225-WHT	WP99229-WHT
TC/FC 125/250/350/450 (2015)	WP10598/1	WP99177-WHT	WP99178-WHT/YLW	WP99179-WHT	WP99226-WHT
TC 250 (2016)	WP10598/3	WP99177-WHT	WP99178-BLU/YLW	WP99179-WHT	WP99226-WHT
TC 125 - FC 250/350/450 (2016)	WP10598/2	WP99223-WHT	WP99224-BLU	WP99225-WHT	WP99227-BLU
TC 125 - FC 250/350/450 (2017)	WP10598/6	WP99223-WHT	WP99224-WHT	WP99225-WHT	WP99227-WHT
TC/TX 250/300 - FS/FX 350/450 (2017)	WP10598/6	WP99223-WHT	WP99224-WHT	WP99225-WHT	WP99227-WHT
KAWASAKI					
KX 125 / 250 (03-08)	WP10090	WP95610-GRN	WP94291-GRN	WP96011-WHT	WP95611-GRN
KX 250F (04-05)	WP10091	WP95610-GRN	WP94105-GRN	WP96019-WHT	WP95629-GRN
KX 250F (06)	WP10113/1	WP95610-GRN	WP94262-BLK/GRN	WP96030-WHT	WP95512-GRN
KX 250F (07)	WP10113/2	WP95610-GRN	WP94262-GRN/BLK	WP96030-WHT	WP95512-GRN
KX 250F (08)	WP10113/3	WP95610-GRN	WP94262-GRN	WP96030-BLK	WP95512-GRN
KX 250F (09)	WP10113/4	WP95728-GRN	WP94128-GRN/BLK	WP96048-GRN/BLK	WP95788-GRN
KX 250F (10-12)	WP10113/5	WP95728-GRN	WP94128-BLK/GRN	WP96048-GRN/BLK	WP95788-GRN
KX 250F (2013)	WP10113/6	WP99162-GRN	WP99163-GRN/BLK	WP99144-WHT	WP99136-BLK
KX 250F (14-15)	WP10113/7	WP99162-GRN	WP99163-GRN/BLK	WP99144-WHT	WP99136-WHT
KX 250F (2016)	WP10113/8	WP99162-GRN	WP99163-GRN/BLK	WP99144-WHT	WP99136-GRN
KX 250F (2017)	WP10114/9	WP99204-GRN	WP99238-GRN/BLK	WP99206-WHT	WP99207-GRN
KX 450F (06)	WP10114/1	WP95610-GRN	WP94263-BLK/GRN	WP96031-WHT	WP95512-GRN
KX 450F (07)	WP10114/2	WP95610-GRN	WP94263-GRN/BLK	WP96031-WHT	WP95512-GRN
KX 450F (08)	WP10114/3	WP95610-GRN	WP94263-GRN	WP96031-WHT	WP95512-GRN
KX 450F (09)	WP10114/4	WP95728-GRN	WP94129-GRN/BLK	WP96048-GRN/WHT	WP95788-GRN
KX 450F (10-11)	WP10114/5	WP95728-GRN	WP94129-BLK/GRN	WP96048-GRN/WHT	WP95788-GRN

OFF-ROAD PLASTIC KITS

MAKE / MODEL	KIT P/N	FRONT FENDER	RADIATOR COVERS	SIDE PANELS	REAR FENDER
KAWASAKI					
KX 450F (09)	WP10114/4	WP95728-GRN	WP94129-GRN/BLK	WP96048-GRN/WHT	WP95788-GRN
KX 450F (10-11)	WP10114/5	WP95728-GRN	WP94129-BLK/GRN	WP96048-GRN/WHT	WP95788-GRN
KX 450F (12)	WP10114/6	WP95728-GRN	WP99143-GRN/BLK	WP99144-WHT	WP99136-GRN
KX 450F (13-15)	WP10114/7	WP99162-GRN	WP99143-GRN/BLK	WP99144-WHT	WP99136-WHT
KX 450F (16-17)	WP10114/8	WP99204-GRN	WP99205-GRN/BLK	WP99206-WHT	WP99207-GRN
KLX-R 450 (07-15)	WP10497	WP95728-GRN	WP99199-GRN/BLK	WP99200-WHT	WP99198-GRN
KTM					
SX /SXF 125 > 525 (05-06)	WP10103/1	WP95612-ORG	WP94115-ORG	/	WP95613E-ORG
EXC/EXCF 125 > 525 (05-07)	WP10103/1	WP95612-ORG	WP94115-ORG	/	WP95613E-ORG
SX /SXF 125 > 505 (07-10)	WP10121	WP95687-ORG	WP94282-BLK	/	WP95679-ORG
EXC/EXCF 125 > 530 (08-09)	WP10121/1	WP95687-ORG	WP94282-BLK	/	WP99124-ORG
EXC/EXCF 125 > 530 (10)	WP10121/10	WP95687-ORG	WP94282-ORG	/	WP99124-ORG
EXC/EXCF 125 > 530 (11)	WP10121/2	WP95687-ORG	WP94282-ORG	/	WP99124-WHT
EXC/EXCF 125 > 500 (12)	● WP10121/3	WP95687-ORG	WP94286-ORG	WP99132-ORG/BLK	WP99145-WHT
EXC/EXCF 125 > 500 (13)	● WP10121/4	WP95687-ORG	WP94286-ORG	WP99132-ORG/BLK	WP99145-ORG
EXC/EXCF 125 > 500 (2014)	● WP10121/5	WP99148-ORG	WP99151-ORG/BLK	WP99167-ORG/BLK	WP99145-ORG
EXC/EXCF 125 > 500 (15-16)	● WP10121/6	WP99148-ORG	WP99151-WHT/ORG	WP99167-ORG/WHT	WP99145-ORG
EXC/EXCF 125 > 500 (2017)	WP10121/7	WP99213-ORG	WP99215-BLK	WP99216-WHT	WP99240-ORG
SX 125 / 150 / 250 (11)	● WP10408/1	WP95687-ORG	WP94286-ORG	WP99132-ORG/BLK	WP95954-WHT
SX 125 / 250 (12)	● WP10408	WP95687-ORG	WP94286-ORG	WP94030-ORG/BLK	WP95954-WHT
SXF 250 / 350 / 450 (11-12)	● WP10408	WP95687-ORG	WP94286-ORG	WP94030-ORG/BLK	WP95954-WHT
SX / SXF 125 > 450 (13-14)	● WP10408/2	WP99148-ORG	WP99151-ORG/BLK	WP99153-ORG/BLK	WP95954-ORG
SX / SXF 125 > 450 (2015)	● WP10408/3	WP99148-ORG	WP99151-WHT/ORG	WP99153-ORG/WHT	WP95954-ORG
SX 250 (2016)	● WP10408/3	WP99148-ORG	WP99151-WHT/ORG	WP99153-ORG/WHT	WP95954-ORG
SX 125/150 - SXF 250/350/450 (2016)	WP10408/4	WP99213-ORG	WP99215-ORG/BLK	WP99216-WHT	WP99219-WHT
SX 125/150 - SXF 250/350/450 (2017)	WP10408/5	WP99213-ORG	WP99215-BLK/WHT	WP99216-WHT	WP99219-ORG
● NOTE: THESE KTM PLASTIC KITS DO NOT INCLUDE SIDES NUMBER PLATES					
SUZUKI					
RM 125 / 250 (01-08)	WP10095	WP95601-YLW	WP94230-YLW	WP96004-WHT	WP95602-YLW
RMZ 250 (04-06)	WP10096	WP95610-YLW	WP94104-YLW	WP96019-WHT	WP95629-YLW
RMZ 250 (07-09)	WP10123	WP95601-YLW	WP94284-YLW	WP96037-WHT	WP95688-YLW
RMZ 250 (10-12)	WP10252	WP95505-YLW	WP94136-YLW/BLK	WP96052-YLW/BLK	WP95529-YLW
RMZ 250 (2013)	WP10252/1	WP95505-YLW	WP94136-YLW/BLK	WP96052-WHT/BLK	WP95529-BLK
RMZ 250 (14-16)	WP10252/2	WP95505-YLW	WP94136-YLW/BLK	WP96052-BLK/YLW	WP95529-BLK
RMZ 250 (2017)	WP10252	WP95505-YLW	WP94136-YLW/BLK	WP96052-YLW/BLK	WP95529-YLW
RMZ 450 (05-06)	WP10097	WP95601-YLW	WP94114-YLW	WP96038-WHT	WP95655-YLW
RMZ 450 (07)	WP10124	WP95601-YLW	WP94285-YLW	WP96038-WHT	WP95655-YLW
RMZ 450 (08)	WP10147/1	WP95505-YLW	WP94125-YLW/BLU	WP96015-WHT	WP95525-YLW
RMZ 450 (09-12)	WP10147/2	WP95505-YLW	WP94125-YLW/BLK	WP96015-WHT	WP95525-YLW
RMZ 450 (2013)	WP10147/3	WP95505-YLW	WP94125-YLW/BLK	WP96015-WHT	WP95525-BLK
RMZ 450 (14-16)	WP10147/4	WP95505-YLW	WP94125-YLW/BLK	WP96015-YLW	WP95525-BLK
RMZ 450 (2017)	WP10147/5	WP95505-YLW	WP94125-YLW/BLK	WP96015-BLK	WP95525-YLW
YAMAHA					
YZ 125 / 250 (02-05)	WP10107	WP95522-BLU	WP94260-BLU	WP96006-WHT	WP95605-BLU
YZ 125 / 250 (06-12)	WP10116	WP95513-BLU	WP94260-BLU	WP96006-WHT	WP95605-BLU
YZ 125 / 250 (13-14)	WP10116/1	WP95513-BLU	WP94260-BLU	WP96006-WHT	WP95605-WHT
YZ 125 / 250 (15-17)	WP10116/2	WP95536-BLU	WP99183-BLU	WP99185-WHT	WP99186-BLU
YZF 250 / 450 (03-05)	WP10106	WP95522-BLU	WP94292-BLU	WP96013-WHT	WP95614-BLU
YZF 250 / 450 (06-09) ●	WP10117	WP95513-BLU	WP94261-BLU	WP96029-WHT	WP95514-BLU
YZF 250 / 450 (06-09) ○	WP10117/2	WP95513-WHT	WP94261-WHT	WP96029-WHT	WP95514-WHT
YZF 250 (10)	WP10261	WP95536-BLU	WP94137-BLU	WP96056-BLK/WHT	WP95533-BLU
YZF 250 (11-12)	WP10272	WP95536-BLU	WP94137-BLU/WHT	WP96056-BLK/WHT	WP95533-BLU
YZF 250 (2013)	WP10272/1	WP95536-BLU	WP94137-BLU/WHT	WP96056-BLK/WHT	WP95533-WHT
YZF 250 (14-17)	WP10272/2	WP95536-BLU	/P99172-BLU/BLK/WH	WP99174-BLK/WHT	WP99171-BLU
YZF 450 (10)	WP10264	WP95536-BLU	WP94138-BLU/BLK	WP96044-BLK/WHT	WP95789-BLU
YZF 450 (11-12)	WP10274	WP95536-BLU	WP94138-BLU/WHT	WP96044-BLK/WHT	WP95789-BLU
YZF 450 (2013)	WP10274/1	WP95536-BLU	WP94138-BLU/WHT	WP96044-BLK/WHT	WP95789-WHT
YZF 450 (14-17)	WP10272/2	WP95536-BLU	/P99172-BLU/BLK/WH	WP99174-BLK/WHT	WP99171-BLU
WRF 250 (07-12)	WP10136	WP95513-BLU	WP94329-BLU	WP96043-WHT	WP95694-BLU
WRF 250 (13-14)	WP10136/1	WP95513-BLU	WP94329-BLU	WP96043-WHT	WP95694-WHT
WRF 250 (15-17)	WP10136/2	WP95536-BLU	/P99172-BLU/BLK/WH	WP99174-BLK/WHT	WP99187-BLU
WRF 450 (07-11)	WP10136	WP95513-BLU	WP94329-BLU	WP96043-WHT	WP95694-BLU
WRF 450 (12-15)	WP10136/3	WP95536-BLU	WP94137-BLU/WHT	WP99173-WHT	WP95694-BLU
WRF 450 (16-17)	WP10136/2	WP95536-BLU	/P99172-BLU/BLK/WH	WP99174-BLK/WHT	WP99187-BLU

WRP STREET
CONTROLS
BRAKE PADS
CHAINS
CANOPIES / TENTS

WRP OFF-ROAD
CONTROLS
BEARINGS & COMPONENTS
BRAKE DISCS
BRAKE PADS
CHAINS
SPROCKETS
PROTECTIONS
AIR & OIL FILTERS
PLASTICS
CANOPIES / TENTS



T-SHIRT BLACK
T-SHIRT WHITE
POLO BLACK
POLO WHITE
HAT

321-014-W
321-001-W
322-014
322-001
228-014-W





Paddock Canopies

- EASY-UP CANOPIES WITH ALUMINUM FRAME
- RAINPROOF HEAVY-DUTY NYLON COVER
- TWO SIZES AVAILABLE: 3X3 MT, 3X6 MT
- NYLON SIDE WALLS KIT AVAILABLE (TWO HALF-HEIGHT WALLS, ONE FULL HEIGHT WALL)
- EACH CANOPY INCLUDES TIE-DOWN STAKES, ROPES AND CARRYING BAG

CANOPIES		
DESCRIPTION	COLOURS	P/N
CANOPY TENT 3X3 m / 19 kg	BLACK / BLUE	WQ-CAN10X10A
CANOPY TENT 3X6 m / 30 kg	BLACK / BLUE	WQ-CAN10X20A
SIDE WALLS for CANOPY 3X3 m	BLACK / BLUE / RED	WQ-SIDES10X10-3
SINGLE SIDE WALL for CANOPY 3X3 m	BLACK / BLUE / RED	WQ-SIDES10X10-1
HALF SIDE WALLS for CANOPY 3X3 m (3 SIDES) BACK SIDE: FULL HEIGHT TWO-SIDES: HALF HEIGHT ALUMINUM CROSSBARS INCLUDED	BLACK / BLUE / RED	WQ-SIDES10X10-H
SIDE WALLS for CANOPY 3X6 m	BLACK / RED / BLUE	WQ-SIDES10X20-3
SINGLE SIDE WALL for CANOPY 3X6 m	BLACK / BLUE	WQ-SIDES10X20-1
HALF SIDE WALLS for CANOPY 3X6 m (3 SIDES) BACK SIDE: FULL HEIGHT TWO-SIDES: HALF HEIGHT ALUMINUM CROSSBARS INCLUDED	BLACK / RED / BLUE	WQ-SIDES10X20-H
CANOPY TOP 3X3 m	BLACK / BLUE / WHITE	WQ-FABRIC10X10
CANOPY TOP 3X6 m	BLACK / BLUE / WHITE	WQ-FABRIC10X20
CANOPY FRAME 3X3 m	-	WQ-FRAME10X10A
CANOPY FRAME 3X6 m	-	WQ-FRAME10X20A

WRP STREET
CONTROLS
BRAKE PADS
CHAINS
CANOPIES / TENTS

WRP OFF-ROAD
CONTROLS
BEARINGS & COMPONENTS
BRAKE DISCS
BRAKE PADS
CHAINS
SPROCKETS
PROTECTIONS
AIR & OIL FILTERS
PLASTICS
CANOPIES / TENTS

MOTO-TECHNICA CLUTCH DISCS

- DESIGNED TO MEET THE NEEDS OF TODAY'S ULTRA POWERED MOTORCYCLES BY PROVIDING GREAT PERFORMANCE AND SUPERIOR DURABILITY
- TWO EXCLUSIVE FRICTION MATERIALS AVAILABLE PERIODS OF HIGH TEMPERATURE
- CONSISTENT AND FADE-FREE PERFORMANCE IN THE MOST DEMANDING CONDITIONS
- DESIGNED FOR USE WITH STOCK DRIVE PLATES AND SPRINGS
- AVAILABLE FOR THE MOST POPULAR STREET AND OFF-ROAD BIKES



**FOR APPLICATIONS
SEE PRICE LIST**

MOTO Technica



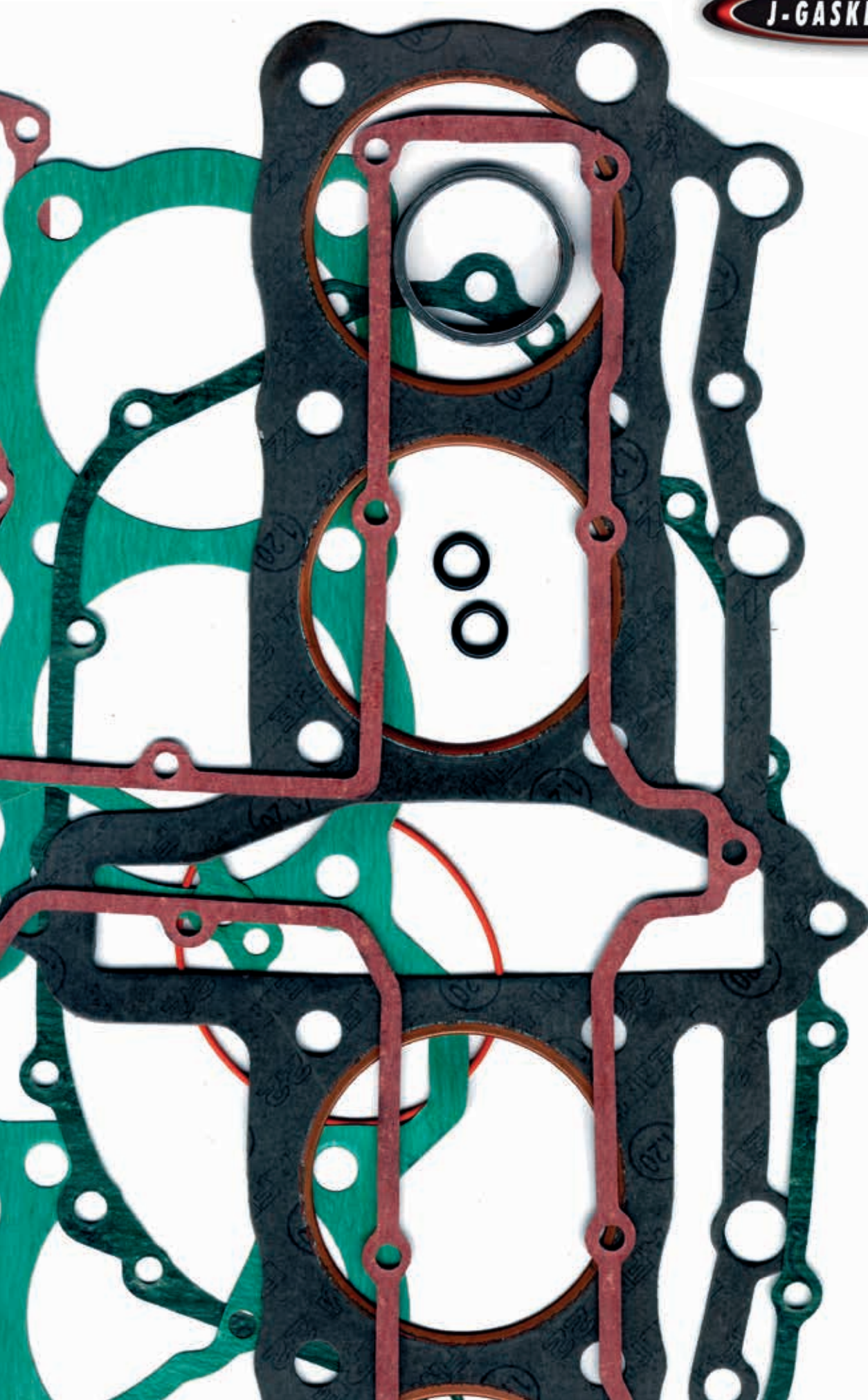

J-GASKETS LINE

- MADE IN ITALY FROM HIGH QUALITY NON-ASBESTOS MATERIAL
- HEAD GASKETS MADE FROM NON-ASBESTOS GRAPHITE LAMINATED TO STAINLESS STEEL CORE
- HIGH RESISTENCE TO HEAT, FUEL, OIL AND CHEMICALS
- AVAILABLE IN BOTH TOP-END OR COMPLETE SET FOR THE MOST POPULAR STREET AND OFF-ROAD BIKES

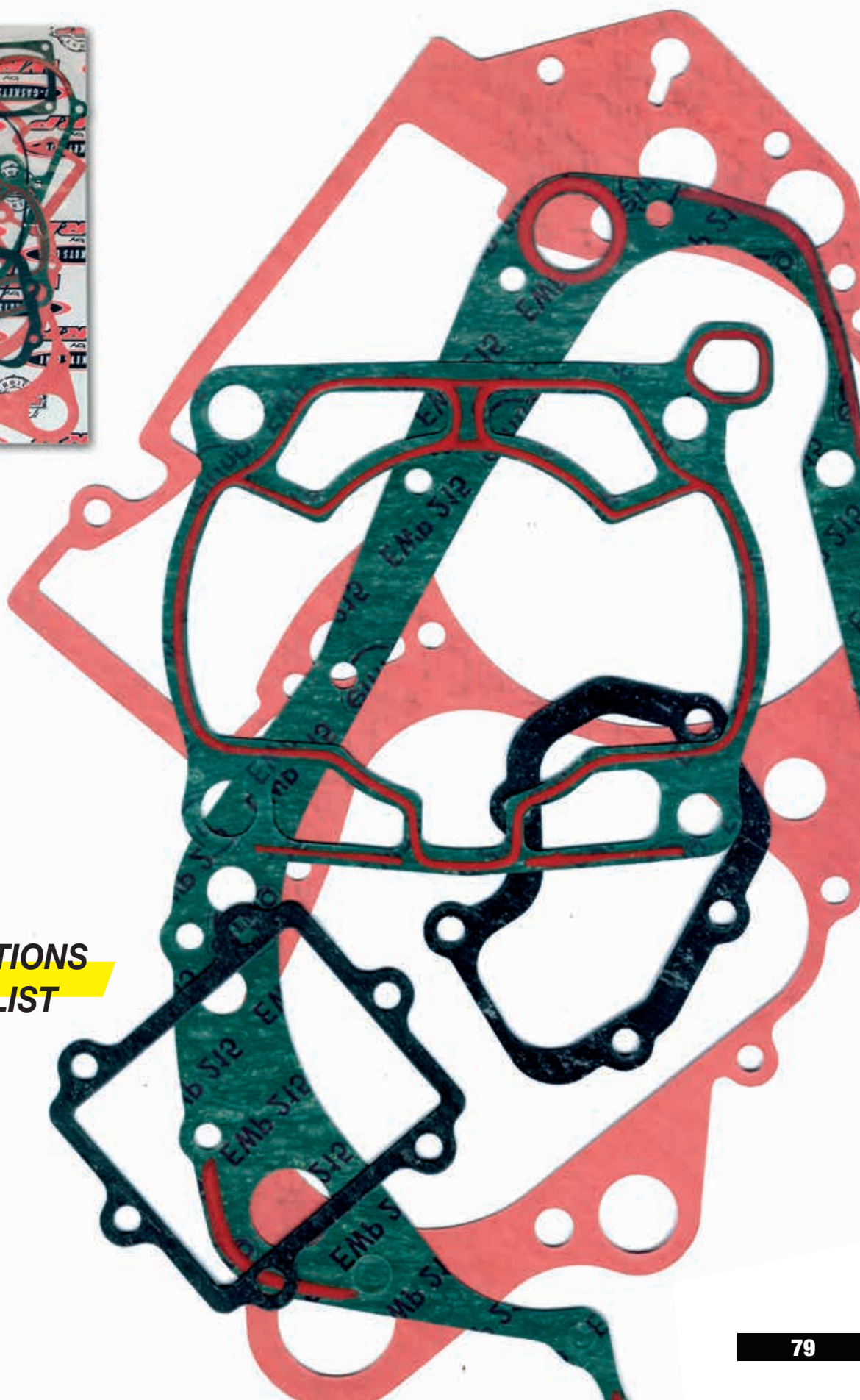

**FOR APPLICATIONS
SEE PRICE LIST**





Wind Trading s.r.l.
via Dismano, 114/g - 48124 Ravenna, Italy

e-mail: windtrading@windtrading.it
tel. +39.0544.64024 - fax +39.0544.470544

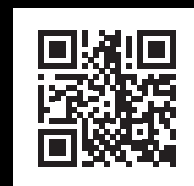

www.wrpracing.com